

# Using the 5180A Waveform Recorder to Evaluate Floppy Disc Media and Drive Electronics

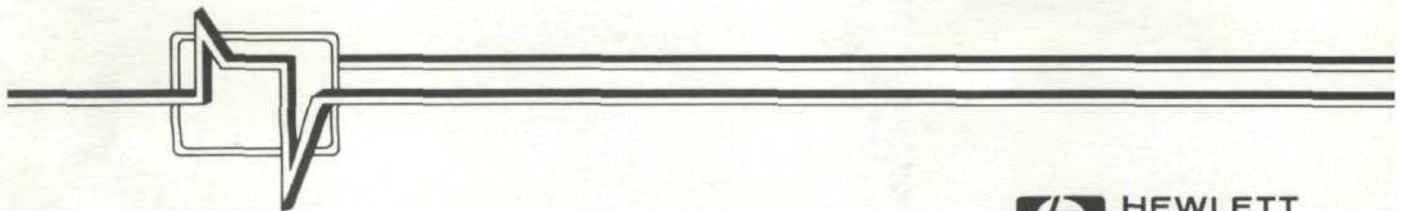

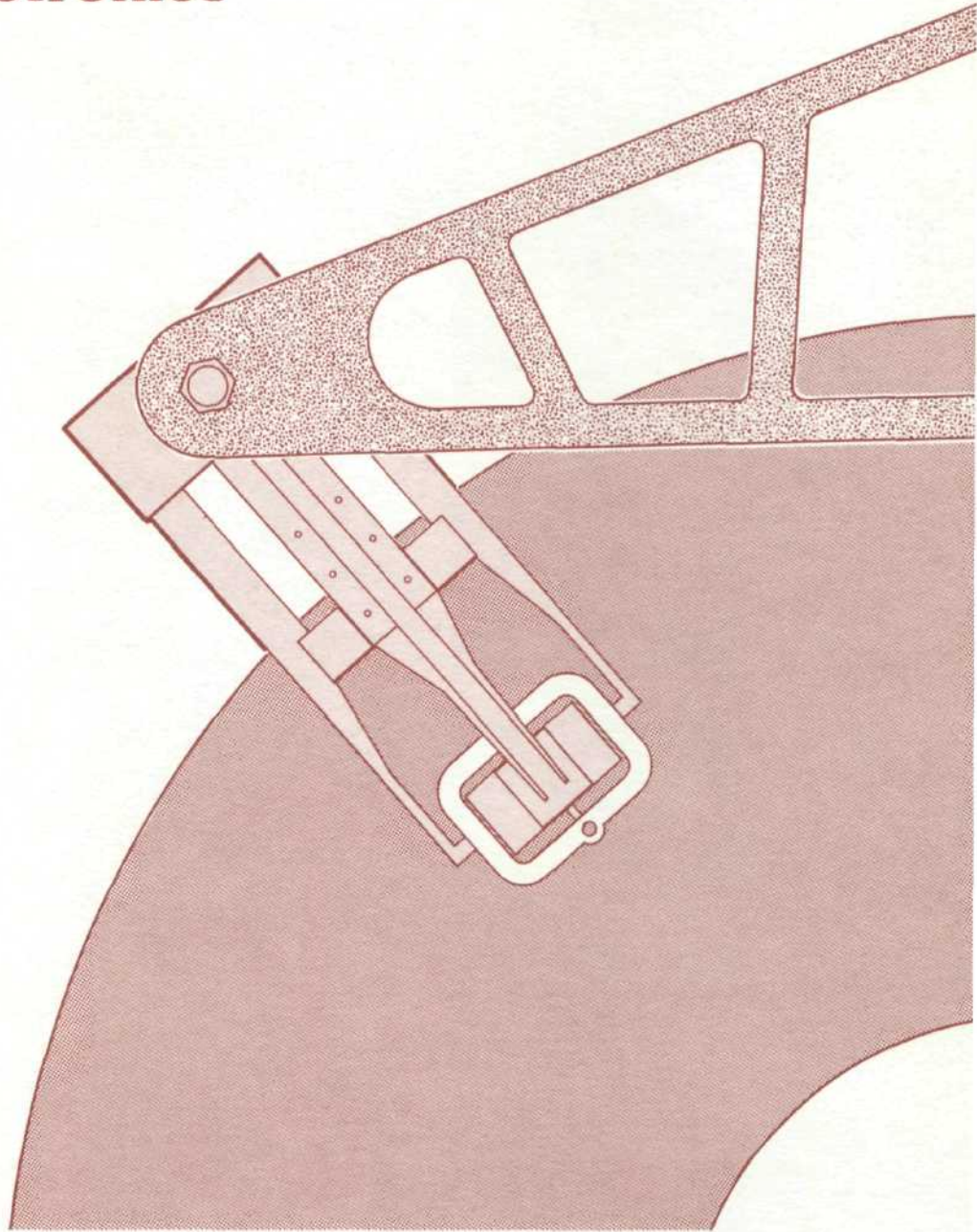
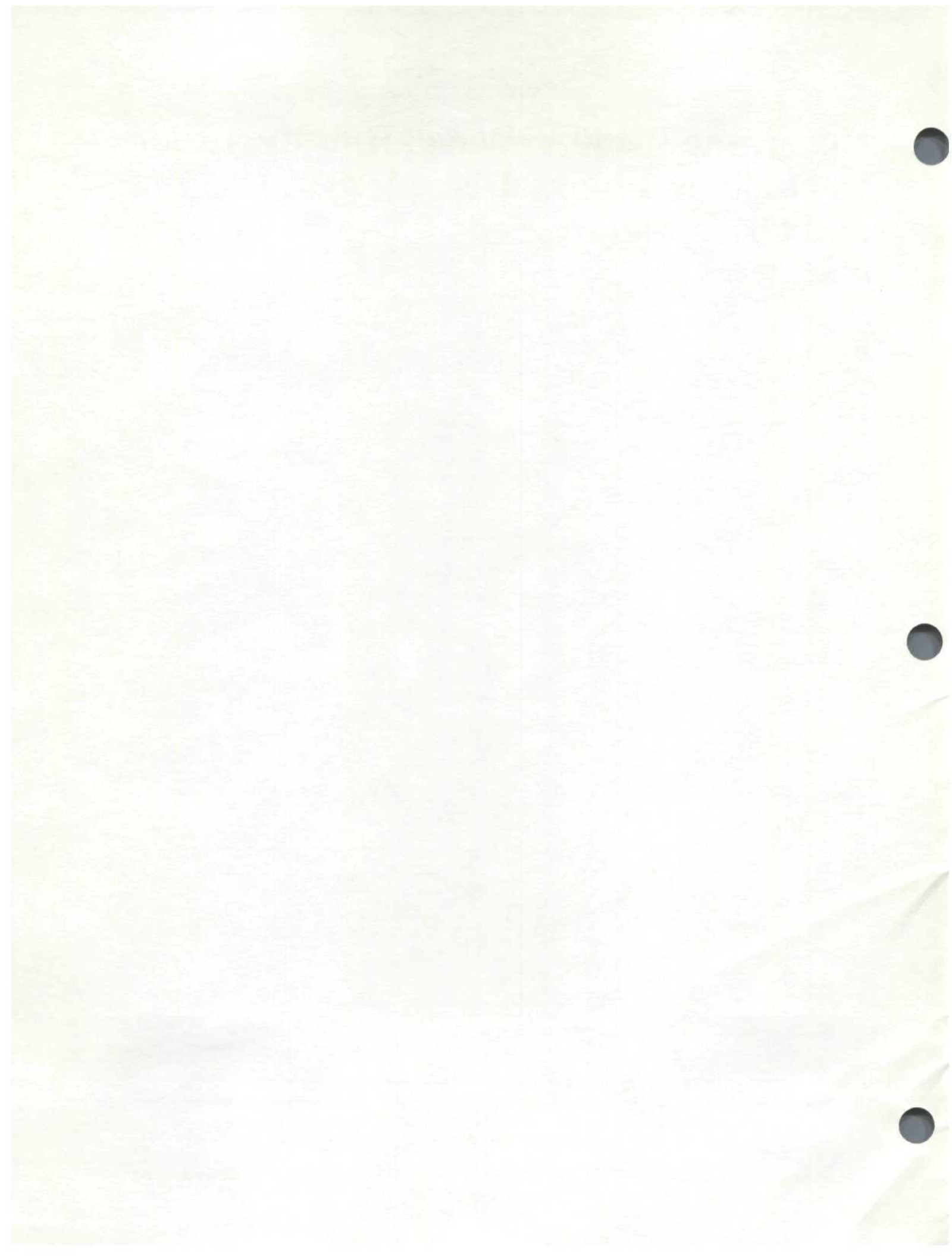

# TABLE OF CONTENTS

<b>INTRODUCTION</b> .....	<b>1</b>
Description of General Application .....	1
<b>DISC MEDIA EVALUATION</b> .....	<b>1</b>
Dropout Capture with a Waveform Recorder .....	2
Hard Dropout Capture, Triggered by CRC .....	2
Soft Dropout Detection for DC-Erased Media .....	5
Read Amplitude Density Testing .....	7
Amplitude Histogram Tests .....	7
Single Sector Amplitude Histogram .....	9
Amplitude Density Model .....	14
<b>ANALYSIS OF DISC DRIVE SIGNALS</b> .....	<b>16</b>
Time Domain Analysis of Disc Drive Signals .....	16
Analysis of Raw Read Waveforms .....	16
Analysis of Conditioned Data Streams .....	21
Frequency Domain Analysis of Disc Drive Signals .....	28
FFT Power Spectrum Algorithm .....	28
Pattern Overwrite and Crosstalk Tests .....	28
Electronics and Media Noise .....	31
<b>APPENDIX I</b> .....	<b>33</b>
Important Waveform Recorder Specifications in Disc Testing .....	33
<b>APPENDIX II</b> .....	<b>35</b>
Demonstration Software .....	35

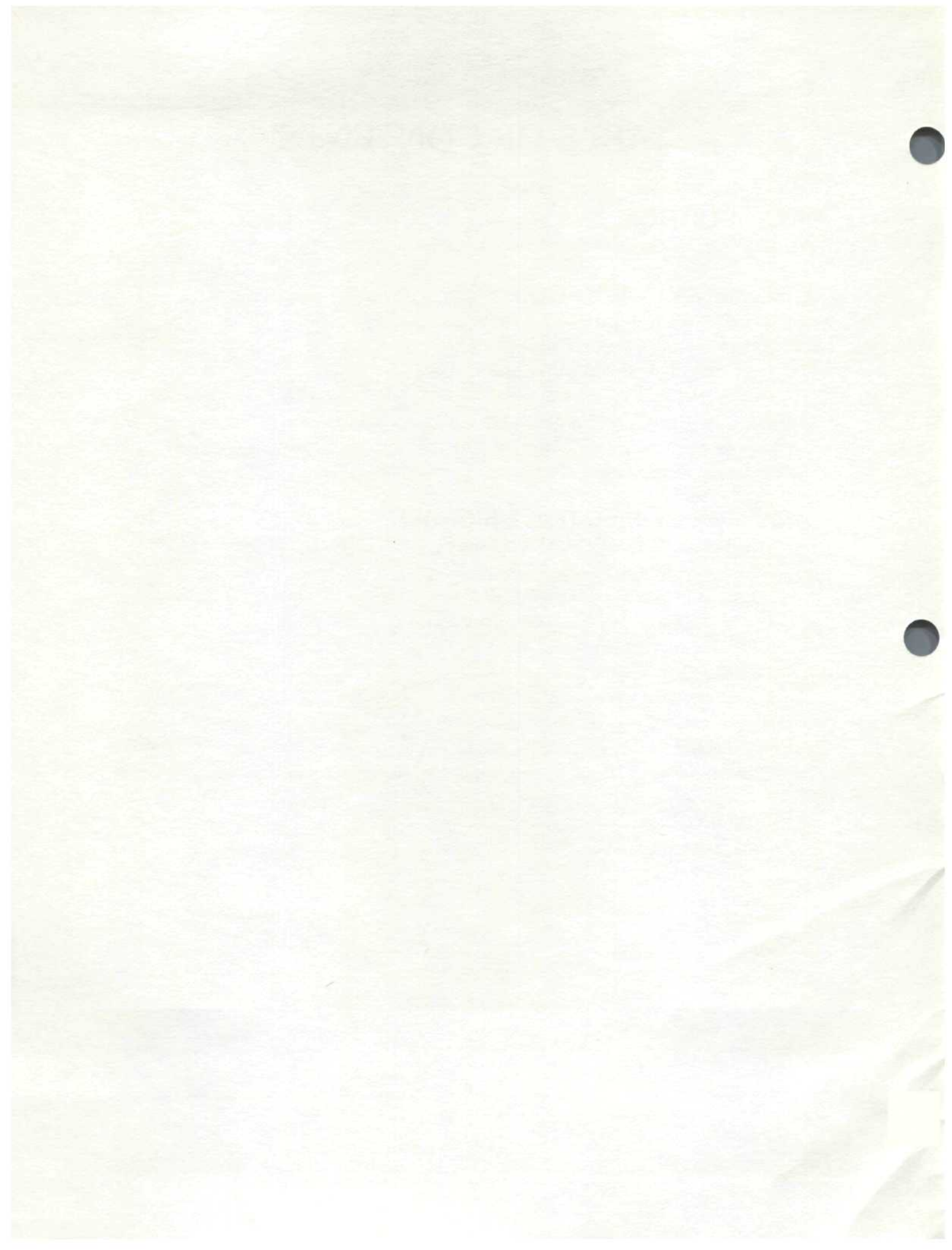

# INTRODUCTION

The 5180A Waveform Recorder, a waveform capture instrument employing a high speed analog-to-digital converter with memory, may be applied in the evaluation of computer disc media and drive electronics and provides new analysis capabilities that are adaptable in an overall disc test strategy. In media surface analysis, the 5180A captures dropout events, enables defect mapping, and offers an improved, cost-effective measurement of coating uniformity. The 5180A, with its powerful systems capabilities, may be combined with digital post-processing routines to improve and simplify drive electronics testing. Direct inspection of read recovery signals provides information needed to improve the drive's performance while maintaining acceptable bit error rates. Tests to measure PW50, pulse symmetry, pattern induced peak shift, and pattern overwrite interference are all accomplished by capturing and processing analog and digital disc drive waveforms.

The principal of capturing characteristic disc waveforms with the waveform recorder and applying post-capture processing with a desktop computer provides unique test benefits:

- a. The waveform recorder, able to perform a variety of time and frequency domain tests, provides a flexible alternative to systems requiring several instruments (oscilloscopes, integrating or peaking voltmeters, spectrum analyzers, and a variety of in-house ETs).
- b. Digitizing dynamic read recovery waveforms provides amplitude, timing, and signal quality information for each bit cell captured. Individual performance parameters are easier to extract because the real-time waveform is accurately represented and may be processed using basic waveform analysis routines.
- c. The test system is flexible in that it may be applied to several types of test problems. Waveform analysis subroutines are quickly implemented in a desktop computer and may be easily reconfigured to test new products or change test limits.

## Description of General Application

This application note presents new disc media and disc electronics test concepts, with applications in design and production, that have been developed using Hewlett Packard's 5180A Waveform Recorder and a 9826 Desktop Computer. The capability of the 5180A Waveform Recorder is demonstrated by applying numerous media and drive circuit tests to a 5 $\frac{1}{4}$ " floppy disc drive. Key specifications for the drive used in the examples are given in Table 1.

TABLE 1. 5 $\frac{1}{4}$ " FLOPPY DRIVE SPECIFICATIONS (used in the test examples)

FORMAT:	DOUBLE DENSITY
ENCODING:	MFM
BIT DENSITY @ 300RPM:	3672 FRPI (outer track) 5456 FRPI (inner track)
TRACK DENSITY:	48 TPI, TWO SIDES
TRACK NUMBERING:	OUTER: 0 INNER: 32
BYTES/SECTOR:	256
READ BURST RATE:	12.8K BYTES/SEC
MFM 2F FREQUENCY:	125KHz (fundamental)
MFM 1F FREQUENCY:	62.5 KHz (fundamental)

The main body of discussion has been separated for clarity, into tests and results for Disc Media Evaluation and Disc Drive Testing. Additional implementation information is given in the Appendix.

## DISC MEDIA EVALUATION

The bit error rate for any magnetic recording mechanism ultimately depends on the quality of the recording media. The uniformity of particulate and plated magnetic coatings may be inspected by digitizing read head waveforms produced by test patterns recorded on the disc. The 5180A's memory size (16384 measurement words) and flexible pre-triggering (up to 100% of the captured record) are key features that support a variety of media test methods. Implementation concepts and test results for drop-out capture, defect mapping, and surface uniformity inspections are covered.

## Dropout Capture with a Waveform Recorder

Temporary signal loss in a disc read operation may be caused by a number of factors—surface contamination, thin or bumpy oxide coating, transient noise in the read channel, or vibration that induces excessive head-media separation. Well known terms define the related signal loss as drop-out, drop-in, hard or soft. For all of these conditions the capture and inspection techniques are similar: apply the waveform recorder's single shot capture and pre-trigger features to inspect the event. Various measurement techniques enable capturing different types of dropouts.

A definition of dropout types helps understand the different capture methods that will be used. The major differentiation depends if a drop-out is *hard* or *soft*. *Hard* drop-outs are those that cause a read data error and will be captured using an error flag from the disc controller, called CRC, for "cyclic redundancy code". *Soft* drop-outs are fairly elusive, may or may not cause a read data error, and are treated as marginal amplitude conditions. Signal amplitude requirements must be imposed to identify soft drop-outs. Amplitude discrimination is particularly useful in test spindle procedures, where a disc operating system and CRC check-sum are not available.

### Hard Dropout Capture, Triggered by CRC

A common method for verifying read data streams involves storing a cyclic redundancy code (CRC) at the end of a sector. The value of the CRC code is a "signature" of the one-zero pattern recorded in the data field. The reproduced data stream in a sector read operation is verified by comparing a calculated CRC signature with the stored CRC. The disc controller flags the host controller when the two don't match. This error flag, usually a TTL or ECL level, is used to trigger the 5180A. Figure 1 shows the equipment set-up for CRC-triggered dropouts.

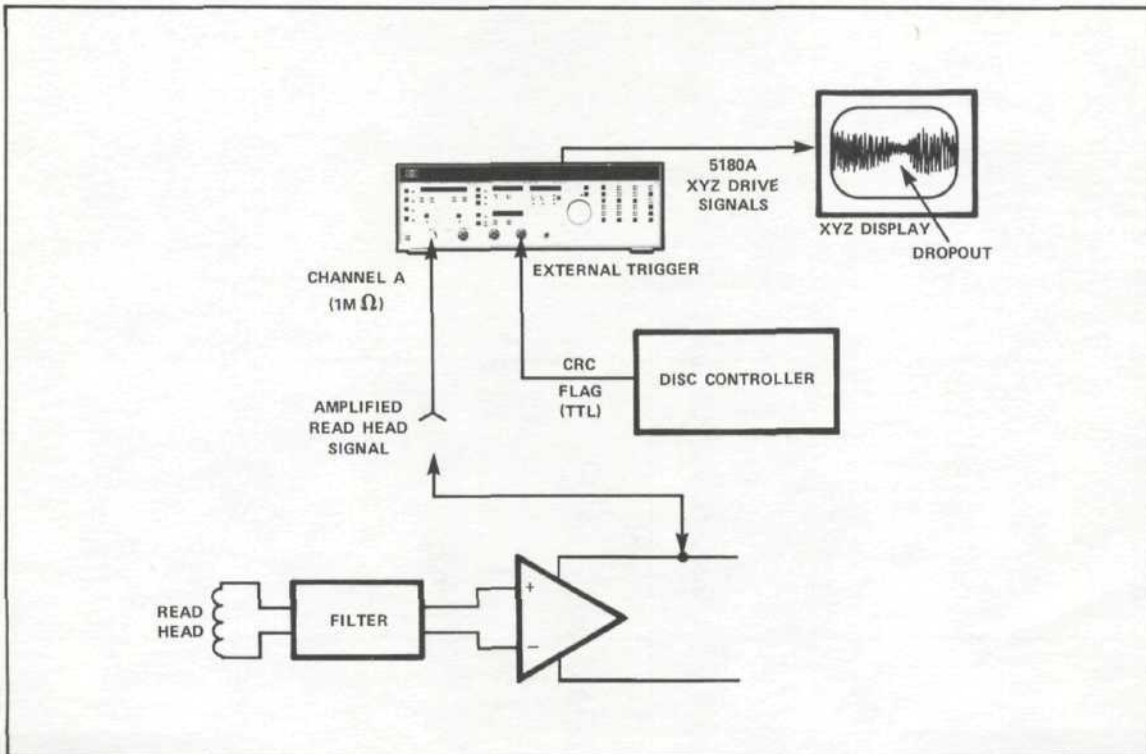

**Figure 1.** Equipment setup for CRC pre-trigger dropout capture. A CRC flag from the disc controller pre-triggers the 5180 at -100%.

Sector read errors are easily identified by capturing the amplified read head signal. A large pre-trigger percentage (usually 100% of the captured record) allows triggering at the end of the sector while recording analog information that caused the error (located in the data field). Figure 2 explains how CRC pre-triggering is used to capture and examine data field read signals. The 5180A's 16K word

memory length allows capturing long segments of sector data, even at higher sampling speeds. Table 2 lists several combinations of measurement sweep times at 100% pre-trigger using a 16384 word record length. The pre-trigger range for the 5180A is 0% to 100% and may be specified in percent of record or absolute time. Record length may be one of the following: 512, 1024, 2048, 4896, 8192, or 16384 points.

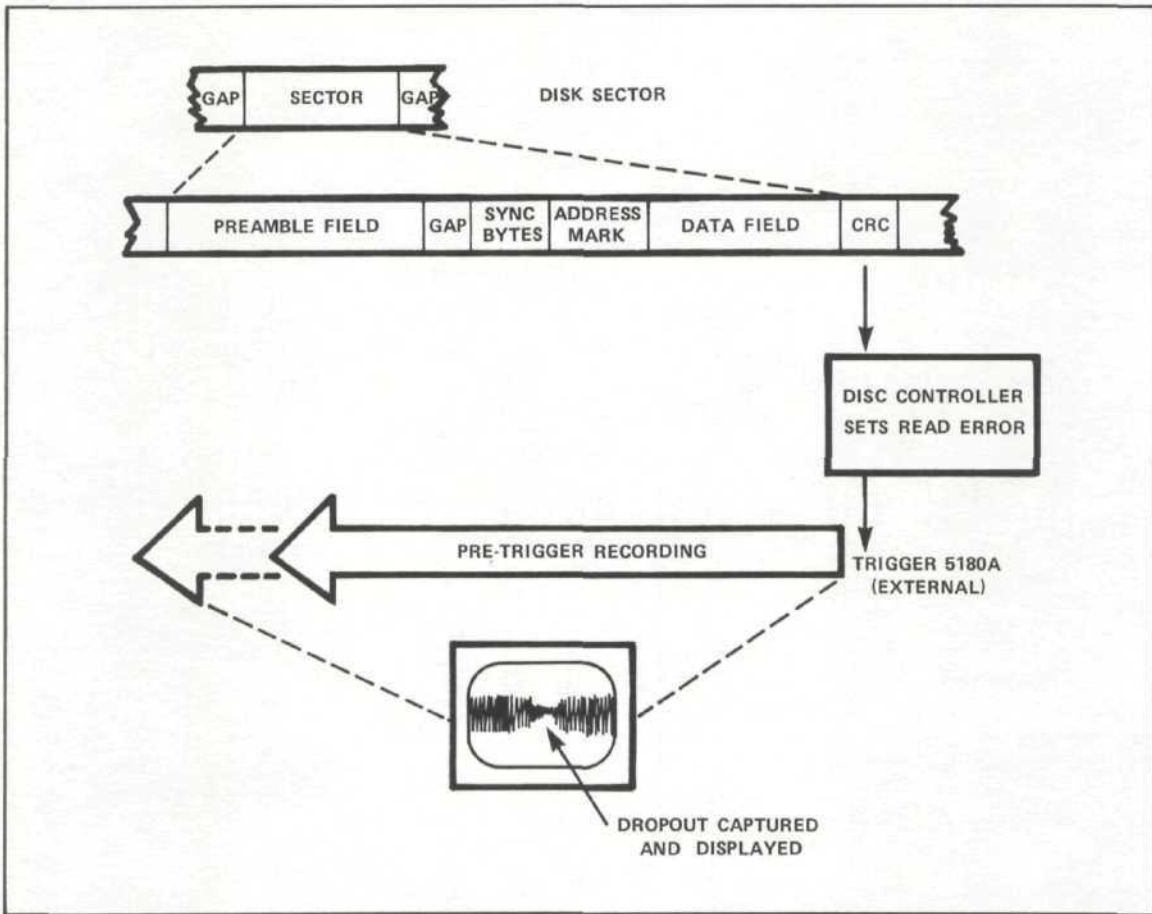

**Figure 2.** Using pre-trigger recording to capture hard dropouts. The waveform recorder is triggered by the disc controller's CRC flag. Various degrees of pre-trigger allow the measurement window to extend back into the data field or further depending on record length and sample period.

TABLE 2. 100% PRE-TRIGGER SWEEP TIMES

PRE-TRIGGER SWEEP TIME = (PRETRIGGER %) (RECORD LENGTH) (TIME/SAMPLE)	
RECORD LENGTH = 16384 POINTS (MAXIMUM)	
SAMPLE PERIOD (TIME/PT)	PRE-TRIGGER TIME (100 PRE-TRIGGER)
50 nsec	819 $\mu$ sec
100 nsec	1.64 msec
200 nsec	3.28 msec
500 nsec	8.19 msec
1 $\mu$ sec	16.4 msec
2 $\mu$ sec	32.8 msec
5 $\mu$ sec	81.9 msec

**NOTE**

Numerous sweep times are available using different combinations of record length, pre-trigger percentage, and sample rate.

Two types of hard dropouts were captured using the 5180A and CRC triggering. Figure 3 shows a captured read signal that has two single cell dropouts. A repetitive sector read/write operation was used to step through all sectors (write, step away, re-step, read). The 5180A was armed to capture the event, then left unattended for the remainder of the test. The errors occurred after several days of operation. The actual cause of the dropout was a random noise transient that interfered during a write process, distorting the read signal in two of the cells.

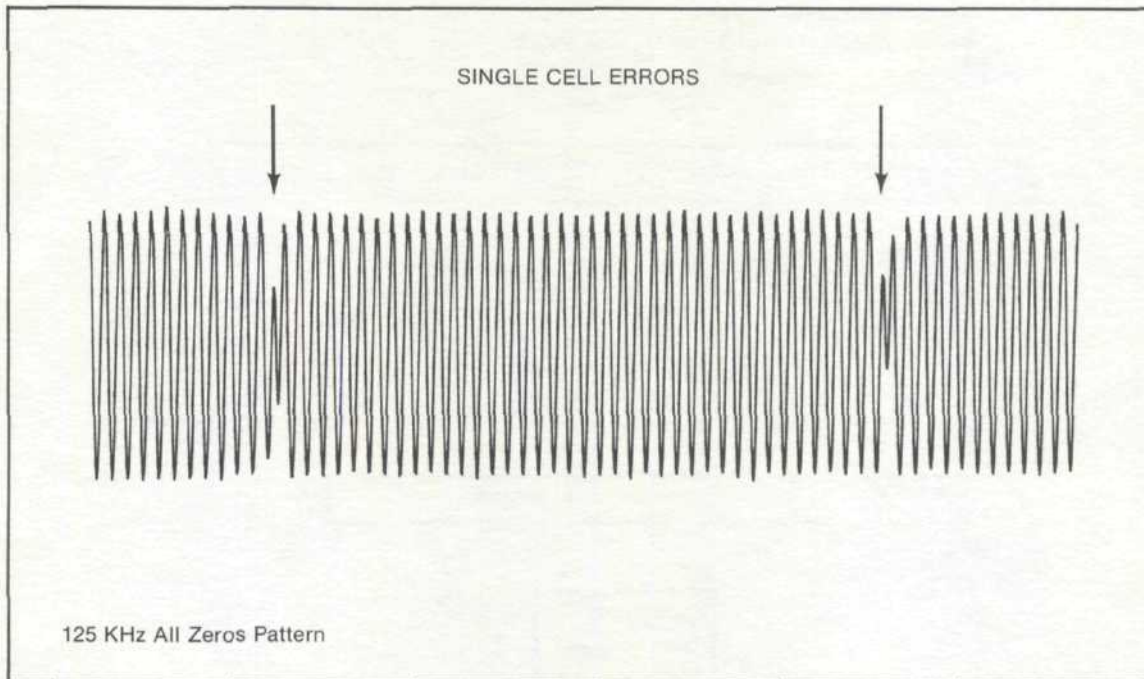

**Figure 3.** Single cell dropouts triggered by CRC and captured using -95% pre-trigger and a record length of 16384 samples. The sample period is 500 nsec/sample and display zoom is 1024 points (display covers 1024 consecutive points in the 16384 point record). Input Range: 1V; signal amplitude: 0.488V peak.

Hard dropouts, when caused by media imperfections or contamination, typically create voltage drops that spread over several bitcells. A long zone dropout was simulated by bringing a small magnetic probe close to the test disc surface, erasing part of a sector data field. A repetitive sector read operation addressed consecutive data fields beginning at the outer track. When the "exposed sector" was read the 5180A triggered on the CRC flag and captured the entire sector data field. Figure 4 is a plot of the captured head signal and was produced using the 5180A HP-GL graphics dump. The top trace shows the unexpanded read waveform, with the amplitude reduced by the dropout for a period of 529 usec. The lower trace is an expansion of the upper trace, focused on the middle of the dropout zone and shows that the amplitude was reduced to 90mV p-p. The amplitude outside the dropout was 1.3 V p-p (shown in the upper trace). Using a waveform recorder to capture dropout events improves the quality of defect analysis by providing read amplitude information. The cause of a dropout can often be determined using voltage and time cursors to measure the captured read waveform.



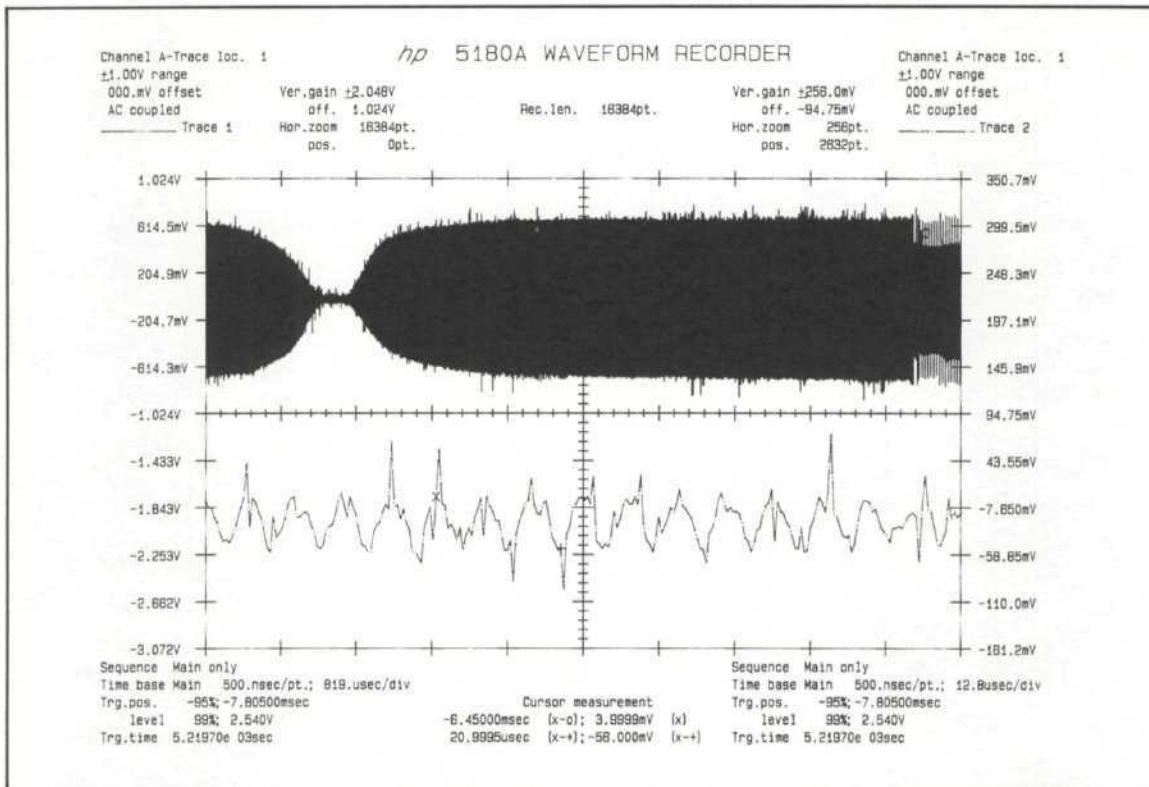

**Figure 4.** Long zone dropout induced by a magnetic probe. The 5180A HP-GL graphics dump feature plots the captured read signal, showing the dropout. The dropout (top trace) is expanded using horizontal zoom and gain (lower trace). The amplitude dropped from 1.3V p-p to 90mV p-p in the dropout zone. The duration of the dropout is 529  $\mu$ sec.

### Soft Dropout Detection for DC-Erased Media

Soft dropouts may not cause a read data error and must be captured using a method other than CRC pre-triggering. An alternate method for locating media defects is based on the capture of voltage pulses that are induced by abrupt flux changes on the disc surface. A DC-erased flawless surface has constant flux, therefore the induced head voltage, except for noise, is zero. Imperfections in the media—particle agglomerations or redeposited oxide (causing drop-ins) or voids (causing drop-outs), are accompanied by abrupt flux changes. Two capture methods may be used to inspect the corresponding voltage pulses: 1. using the waveform recorder's internal trigger (when the geometric location need only be the track), and 2. INDEX pulse external trigger, where location (group of bitcells) is important. Both methods allow imposing precise amplitude discrimination for event capture and are conveniently applied in test stand procedures where un-sectored media is evaluated. Also, DC-erased media tests can be performed faster because test patterns do not have to be pre-written to the disc.

#### DC-ERASED—INTERNAL TRIGGER METHOD

The amplified read head signal is applied to the 5180A's Channel A input and a disc read operation over a DC-erased track is begun. The 5180A bi-trigger feature sets up a threshold window so that trigger occurs if a pulse exceeds described limits.\* The 5180A triggers when the input signal passes through either the more positive or more negative bi-trigger level. Normal media surface imperfections that do not cause a read data error will, however, generate small noise voltages. The hysteresis of the trigger is selected so that the base level noise won't trigger the 5180A. A 50% pre-trigger measurement places the dropout event in the center of the captured record. This bi-trigger implementation is similar to popular test techniques, where a peak detector triggers on voltage pulses. Waveform recorders offer significant advantages in that amplitude information may be inspected to determine the shape and length of the dropout.

\*The waveform recorder's internal trigger mechanism is a critical performance specification. The DC-erased dropout technique requires a reliable trigger mechanism to insure precise control in detecting signal variations related to media imperfections. The 5180A uses a high performance digital trigger to provide confidence in the trigger point. The trigger limits are entered in absolute volts and are converted to digital trigger words for sample-by-sample comparison with the digitizer output.

## BI-TRIGGER TEST ALGORITHMS—DC-ERASED MEDIA

Test procedures for defect detection on DC-erased media use the 5180A stand-alone or in a system. The basic steps for a system approach are covered in the following algorithm. A manual procedure uses the 5180A stand-alone and is drawn from the system approach.

System approach using internal bi-trigger (program control of 5180A)

Allows automatic measurement control and accumulation of test results in the 9826 Desktop computer.

- a. Use the 9826 to program measurement conditions for the 5180A. Set up record length, bi-trigger levels, sample period, pre-trigger position, and input channel range.
- b. ARM the 5180 using the 9826.
- c. Digitize a complete revolution of read head waveform data on the track being tested.
- d. Using the 9826, check the 5180A bus status-byte to see if trigger occurred. If the 5180A triggered, a defect has been located. Store the track location. The 5180A measurement data may also be transferred and saved for later inspection.
- e. If the 5180A did not trigger, send the manual trigger command to abort the measurement. Repeat with step (b).

A manual operation was used to capture the DC-erased dropout event of Figure 5. The width of the dropout voltage pulse was 256  $\mu\text{sec}$ ; sample interval, 1  $\mu\text{sec}/\text{sample}$  and bi-trigger limits  $\pm 70\text{mV}$ .

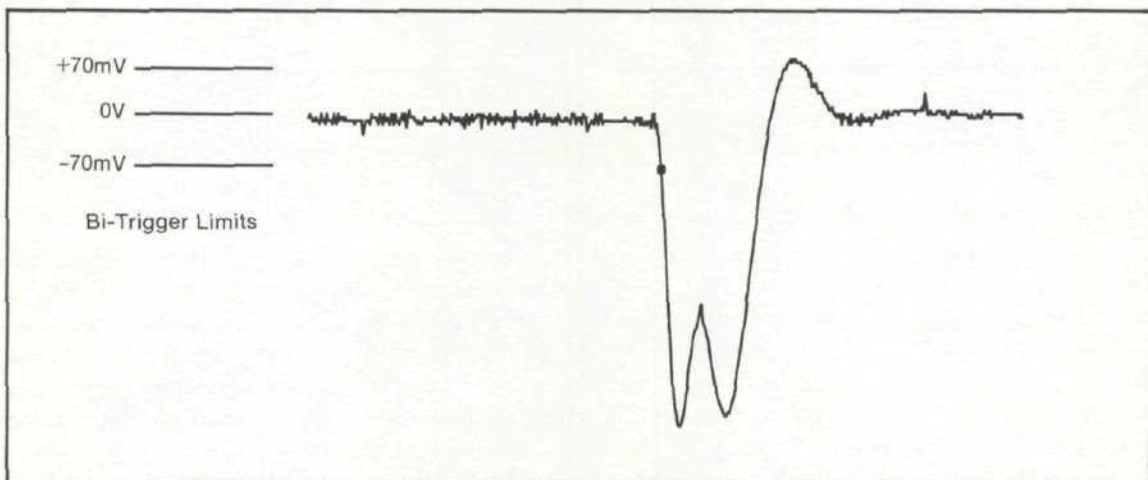

Figure 5. Bi-trigger method used to capture a  $d\phi/dt$  pulse from DC-erased media. The dropout width is 256  $\mu\text{sec}$ . Sample rate: 1  $\mu\text{sec}/\text{sample}$ ; bi-trigger limits  $\pm 70\text{mV}$ .

## AUTOMATIC DC-ERASED DEFECT LOCATION USING INDEXED TRIGGER

An automated approach to locating defects on DC-erased media is based on triggering the 5180A externally with a signal that is geometrically time-referenced to track circumference locations. For the internal bi-trigger tests, the exact location of a defect could not be determined—it was only known that there was a defect at some position on the track. The index pulse, indicating the position of the index hole in a 5¼" floppy, may be used as a trigger source when testing media that has not been sectorized (typically performed on test spindles). By setting the various post-trigger delays, the 5180A can sequentially capture signals coming from all angles for a single revolution. The waveform data for each record is transferred to the 9826 using DMA (direct memory access—a 16-bit parallel high speed I/O bus for 5180A measurement data). A sorting routine scans the captured signal, detects amplitude errors, and logs position information. This indexed trigger method, combined with software controlled limit testing, provides precision and speed in locating surface imperfections.

The 5180A's triggering and systems capabilities provide cost-effective, efficient means of capturing and inspecting media defects. Tests performed with the waveform recorder are more thorough because precise amplitude and position information is available for inspection.

## Read Amplitude Density Testing

Amplitude variations occurring in the read recovery voltage are most often related to non-uniformities in the media coating. Tests based on read amplitude voltage histograms help to reveal the nature of random process variables such as particle size, coating density, and film thickness. In addition, read amplitude density histograms assist in determining surface quality improvements for a given degree of surface preparation (polishing or burnishing).

### Amplitude Histogram Tests

The amplitude histogram is a voltage density plot representing the frequency of occurrence for voltage peak levels of the captured waveform. If a fixed-amplitude write signal is used to record a test pattern on the disc, the resulting density function is a measure of the change in magnetic properties from point to point. Used as a statistical tool, the amplitude histogram can reveal how the read signal depends on geometric location, write current level, data patterns, or frequency of the record signal.

The histogram technique is a two-step process that begins with capturing an MFM all zeros read recovery waveform from a particular zone of the disc, usually all or part of a sector data field. In the second step the waveform data is sorted and the peak voltage for each cycle is cataloged. Programs that collect and plot amplitude density functions for a single sector, track, or entire surface have been developed and applied to the 5¼" floppy drive. Basic steps for implementing the tests along with test results are given in this section. Further details for setting up the amplitude histogram tests are found in the Appendix.

### CAPTURING THE ANALOG WAVEFORM—BURST TIMEBASE TECHNIQUE

The voltage level of consecutive peaks in a sector burst may be determined by capturing and sorting *several cycles of the amplified read waveform*. The voltage accuracy for peak levels depends on the number of points-per-cycle in the captured waveform—more points means better accuracy. For MFM all zeros pattern, a 125KHz sine-like signal is read from the disc. A sample period of 500 nsec/sample places 16 points per cycle, and allows capturing 1024 cycles for a 16K record length. Since only the peak of each cycle is needed, samples that fall on other parts of the waveform are wasted.

A major conservation of waveform recorder memory, along with a savings in processing time is realized by turning the sample clock on and off to digitize only the peaks of the incoming waveform. The same MFM all zeros waveform sampled above using 16 samples per cycle may have 16 samples at closer spacing (250 nsec instead of 500 nsec) about each peak using a "burst timebase technique. The HP 8112A 50 MHz pulse generator is used in counted burst mode to drive the waveform recorder's timebase through an external input. Each time a trigger event is detected by the pulse generator, a counted number of samples (N) will be recorded. By selecting generator trigger delays, sample

spacing, and number of pulses per burst (N), the peaks of the input waveform will be captured. In addition to conserving memory, the technique reduces processing time — each group of N samples contains a peak voltage. The voltage histogram algorithm searches each group of N samples, finds the peak, and catalogs it in a data array. Figure 6 explains the burst timebase method and relates it to the amplitude histogram plot. The equipment connections for the 5180A and 8112A are shown in Figure 7.

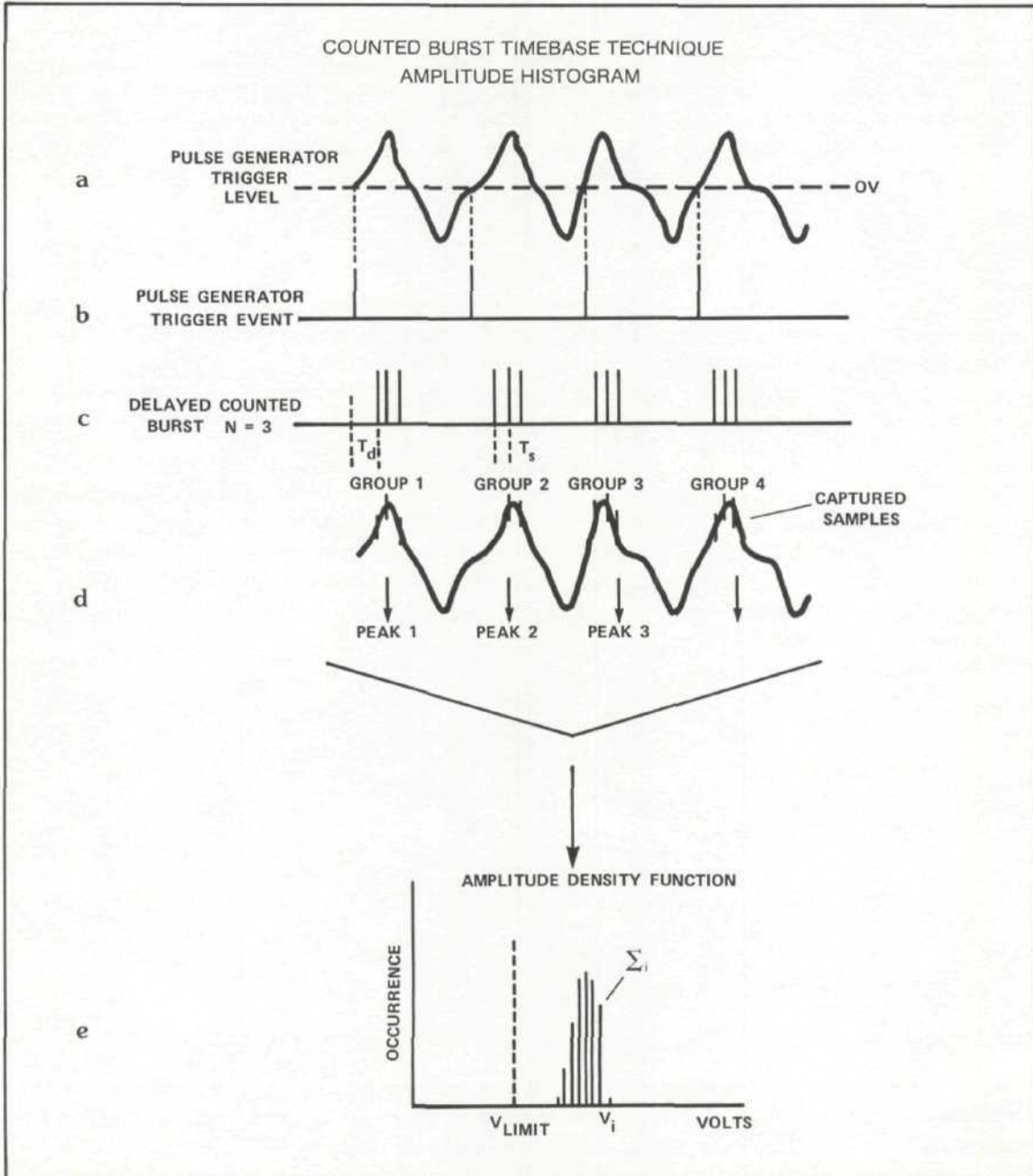

**Figure 6.** Burst timebase example for N=3.

- The read recovery waveform is applied to the 5180A Channel A input and to the 8112A Pulse Generator trigger input. The pulse generator trigger level in the example is set for positive slope, near the zero volts crossing.
- The pulse generator detects a trigger event each time the waveform crosses the selected threshold.
- After a specified trigger delay ( $T_d$ ), the pulse generator produces N pulses spaced by  $T_s$  seconds. This pulse output is used as an external sample clock that drives the 5180A digitizer.
- Each time the input signal crosses the trigger threshold, the waveform recorder captures N samples about the peak.
- The accumulation of peak voltages for all groups is presented in the histogram. The height of each line ( $\Sigma_i$ ) represents the total number of groups that had a peak voltage  $V_i$ .

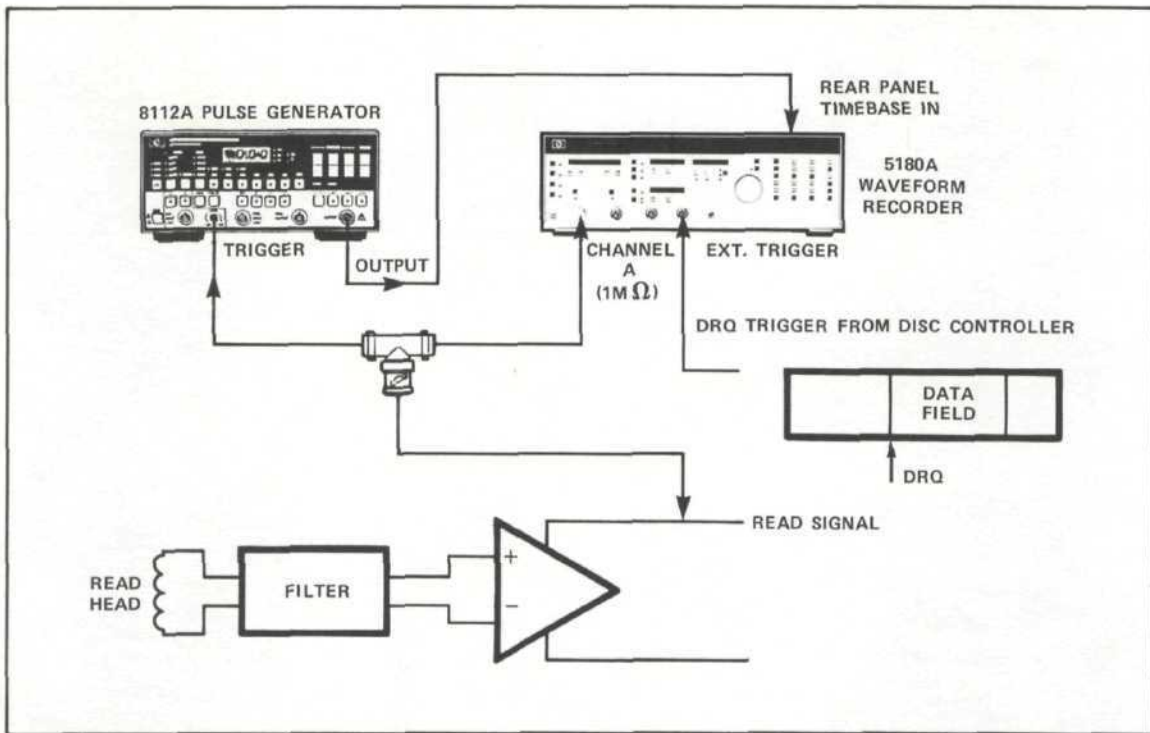

**Figure 7.** Equipment setup for burst timebase capture of analog read waveforms. The 8112A Pulse Generator output is fed to the 5180A timebase input. The pulse generator triggers and produces N pulses each time the read signal crosses a set threshold. Both the 5180A and 8112A are under HP-IB control.

### Single Sector Amplitude Histogram

The single sector histogram catalogs peak amplitudes for each positive waveform transition in the sector data field using the MFM all zeros data pattern (usually called the 2F pattern). MFM 2F produces the highest frequency analog signal (125KHz), creates a transition in each bitcell, and is well suited for the amplitude tests. Other patterns may be applied to check amplitude-pattern dependence by adjusting test parameters for the capture and sorting processes.

The single sector histogram is applied to the 5¼" drive using a burst timebase of 16 samples spaced 250 nsec apart. A full sector of 2F read data is captured by the 5180A. The 16384 record length allows 16 samples per peak and covers a total of 1024 peaks (all positive half cycles in the data field). The time window covered by each burst is 4 usec. Since the 2F pattern produces a 125KHz read signal, each 4 usec burst digitizes the positive one-half cycle. The sorting routine locates any peak that occurs in each group of 16 samples. The 5180A is triggered externally using 0% pre-trigger by a data request signal (DRQ) coming from the disc controller. DRQ falls at the beginning of the sector data field and allows the 5180A to capture only the data field signal.

Figures 8a and 8b are single sector amplitude histogram plots for sectors near the outer and inner tracks respectively. The histogram follows a general shape but the most probable amplitude lowers for sectors on the shorter radius (inner tracks). The histogram base-width is a measure of voltage deviation for all peaks captured. The expected amplitude deviation is 1/2 to 2dB. The (PEAK) voltage labeled on the plot represents the most-probable amplitude value and corresponds to the voltage at which the histogram peaks.

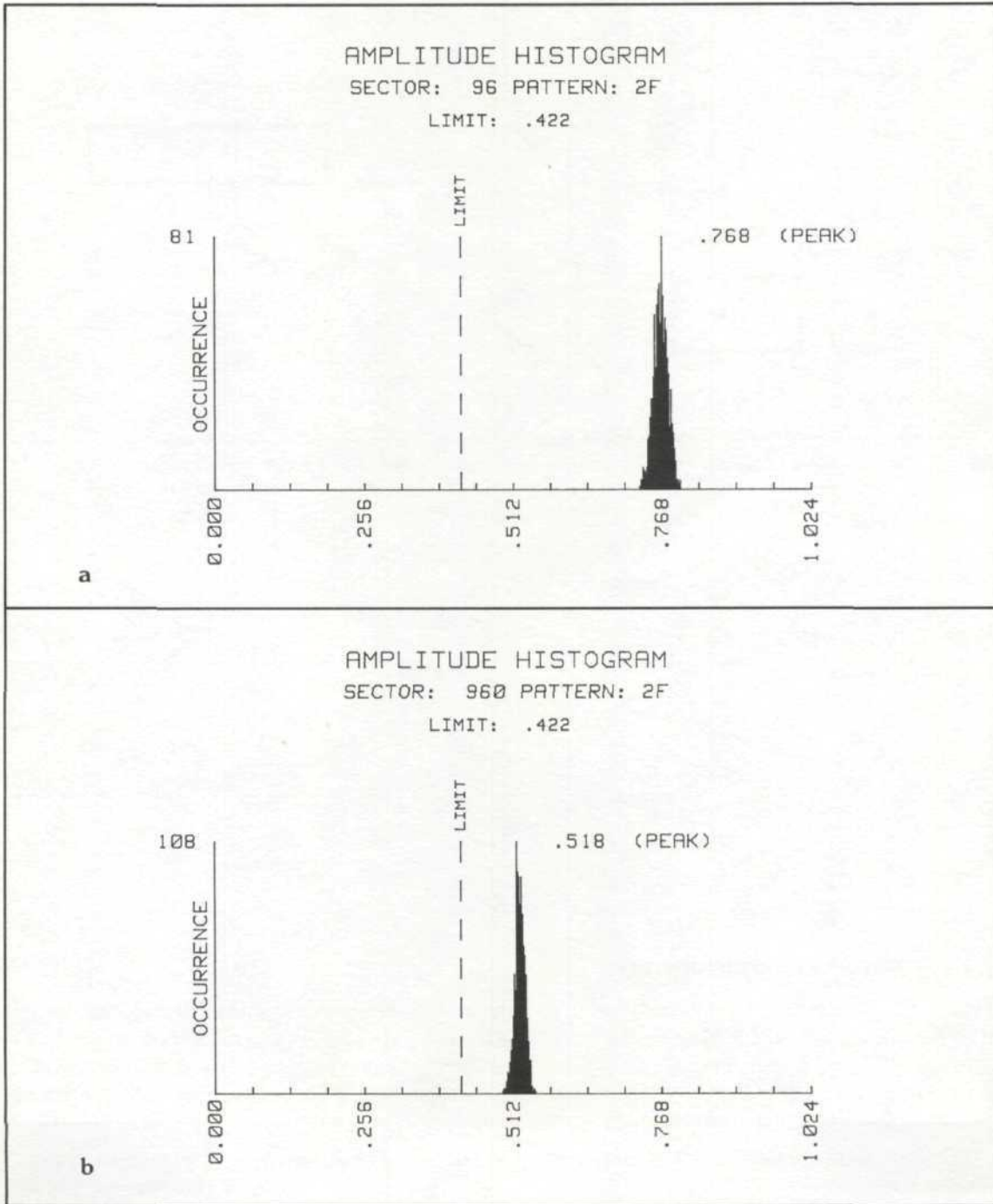

**Figure 8a,b** Amplitude histogram plots for sectors 96 (outer radius) and 960 (inner radius). The histogram plots the frequency of occurrence of read signal peak voltage for a full sector of consecutive bitcells (using 2F pattern). Sectors near the disc's outer radius (Figure 8a; Sector 96) show higher average amplitude but slightly wider basewidth when compared to sectors near the inner track radius (Figure 8b; Sector 960). The (PEAK) value is the most-probable peak voltage for all bitcells in the sector. The test routine catalogs all bitcell locations with peak voltages less than LIMIT.

The amplitude histogram test is a powerful tool in manufacturing lot testing and can provide valuable production control information for dispersion and polishing processes. As a process control example, the amplitude histograms for unburnished and burnished media were formed and are given in Figure 9a and Figure 9b. For the same sector, the burnished media shows a narrower base width and a higher signal amplitude. The width and amplitude information given by the histogram can be used to determine the exact amount of polishing time necessary to produce a given level of surface consistency.

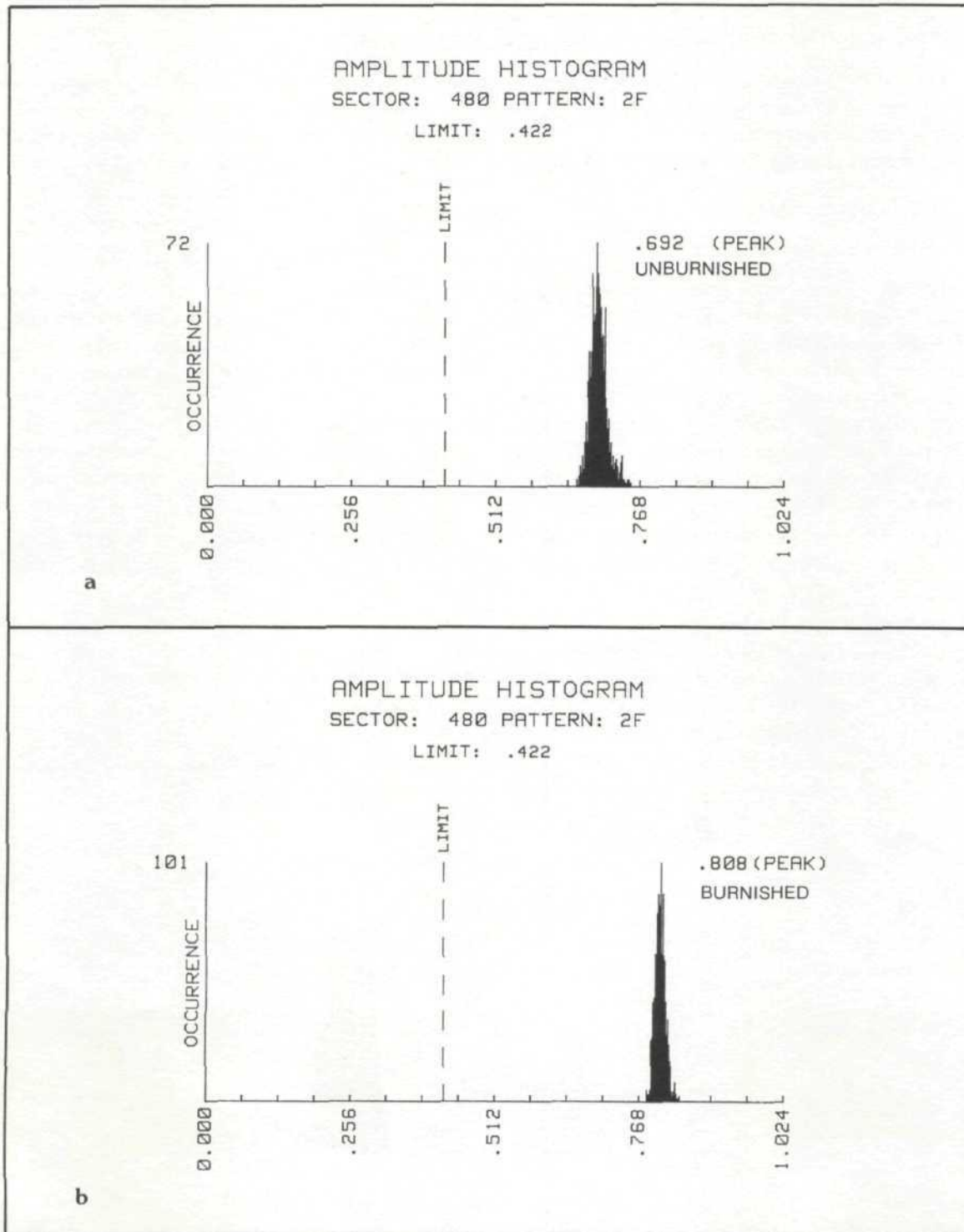

Figure 9a,b Single sector amplitude histograms for un-burnished (Figure 9a) and burnished (Figure 9b) media. Comparison shows that burnished media has a narrower basewidth (0.058 V) and good amplitude (approx. 800mV). The un-burnished media results in a larger basewidth (0.102V) and a lower amplitude (approx. 700mV).

## ADDITIONAL AMPLITUDE HISTOGRAM FEATURES

The probability density data that generates the histogram plot is stored in a data array and provides additional information. For example, the sorting algorithm compares each voltage peak to a preset limit and catalogs the bit position of each failing group. This information may be used to position the 5180A display for post-capture examination of drop-out zones. Amplitude statistics may also be beneficial in the study of soft dropouts, where defect detection is based on signal amplitude.

## EXTENDING THE SINGLE SECTOR AMPLITUDE HISTOGRAM

The single sector amplitude histogram may be applied in gathering data for single tracks or entire disc surfaces. These extensions may also be applied in manufacturing lot testing to provide additional process control information. The amplitude discrimination feature of the single sector histogram test may be applied in defect mapping, cataloging bitcell, sector, and track locations.

## TRACK HISTOGRAMS

The track histogram is an accumulation of single sector amplitude information for all sectors on the track being tested. Two versions of the track test have been applied to the 5¼" drive — a Track Amplitude Histogram that produces an amplitude density plot for all sectors on the track, and a Sector/Amplitude test that graphs average amplitude, sector by sector (sometimes known as the "once around" test).

A Track 2 amplitude histogram plot for the 5¼" floppy is shown in Figure 10. The graph shows the accumulation of all transitions for the 16 sectors that make up the track using MFM 2F as a test pattern. The track histogram algorithm logs all sectors and bitcells that have amplitudes lower than the selected limit. The peak of the Track 2 histogram is located at .802 Volts. The histogram PEAK voltage is generally lower for inner tracks — the same relationship found in single sector plots.

A sector-by-sector amplitude average may be developed using the single sector histogram. Each single sector average is determined by capturing a variable number of transitions so that processing time may be optimized.

A Sector/Amplitude test plots the average sector amplitude as a function of circular position and shows that an amplitude modulation pattern exists about a single revolution. The pattern is linked to particle orientation during the dispersion process. For locations tangent to the orientation the amplitude should be higher. The Track/Amplitude Test displays average sector amplitude for two revolutions of the disc to show amplitude modulation over two adjacent tracks.

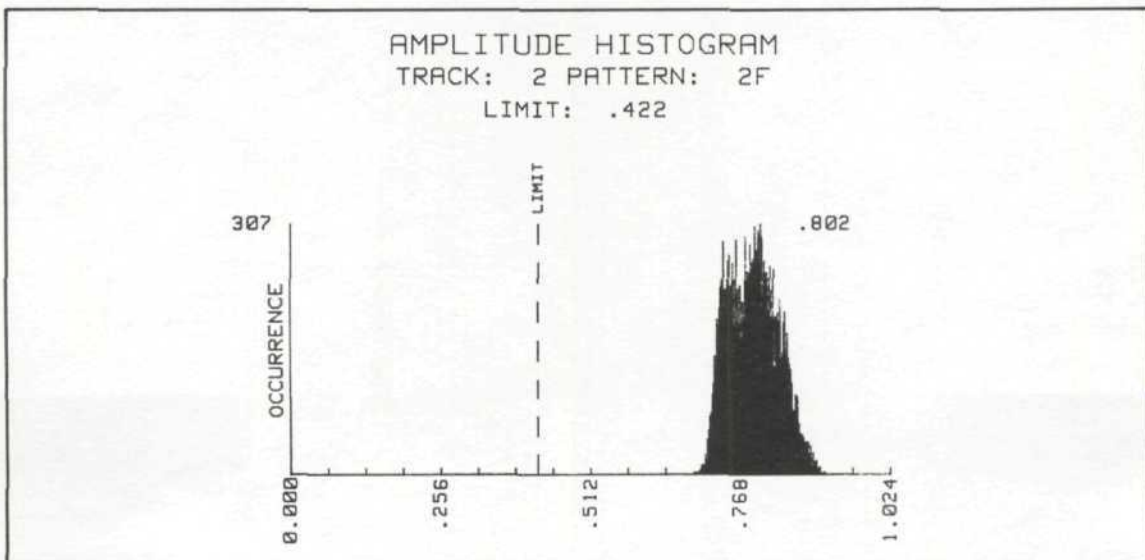
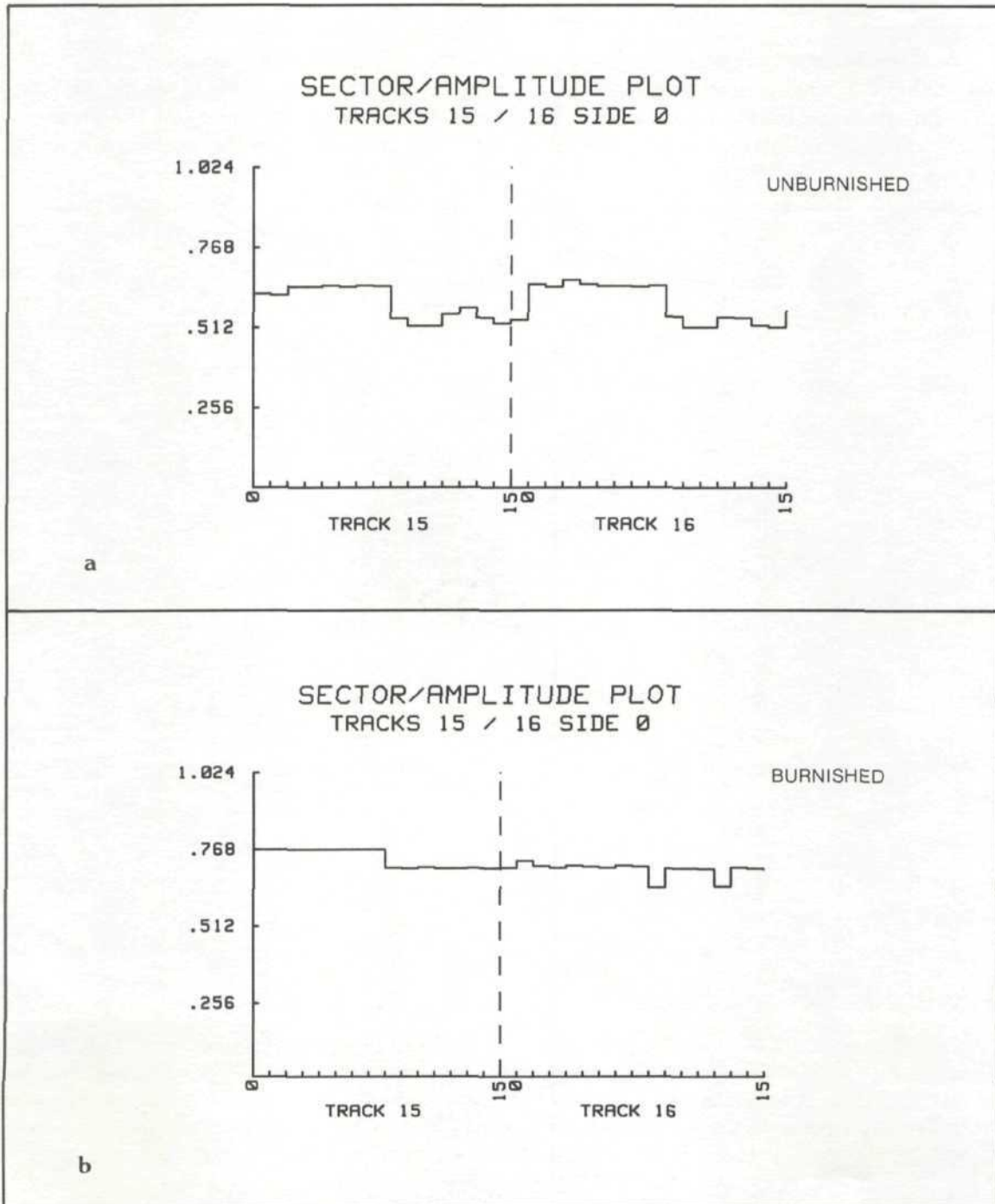

Figure 10. Amplitude histogram for all 16 sectors on Track 2. The histogram data is an accumulation of peak voltages for all sectors (16384 peaks). The most-probable peak voltage is 0.802V, with a basewidth of 242mV. The track, sector, and bitcell location for all peaks less than LIMIT are cataloged.



Two Sector/Amplitude plots were produced—one for unburnished and one for burnished media (unburnished in Figure 11a and burnished in Figure 11b). Note that both plots show amplitude modulation around the disc but that there is less deviation in average sector amplitude for the burnished media. Each Sector/Amplitude plot covers 32 sectors on Tracks 15 and 16. Each sector was captured using a burst-timebase of 16 samples per peak, and a sample period of 250 nsec-per-point (set up by the 8112A Pulse Generator). A 5180A record length of 512 points allowed capturing 32 transitions for each of the 32 sectors.

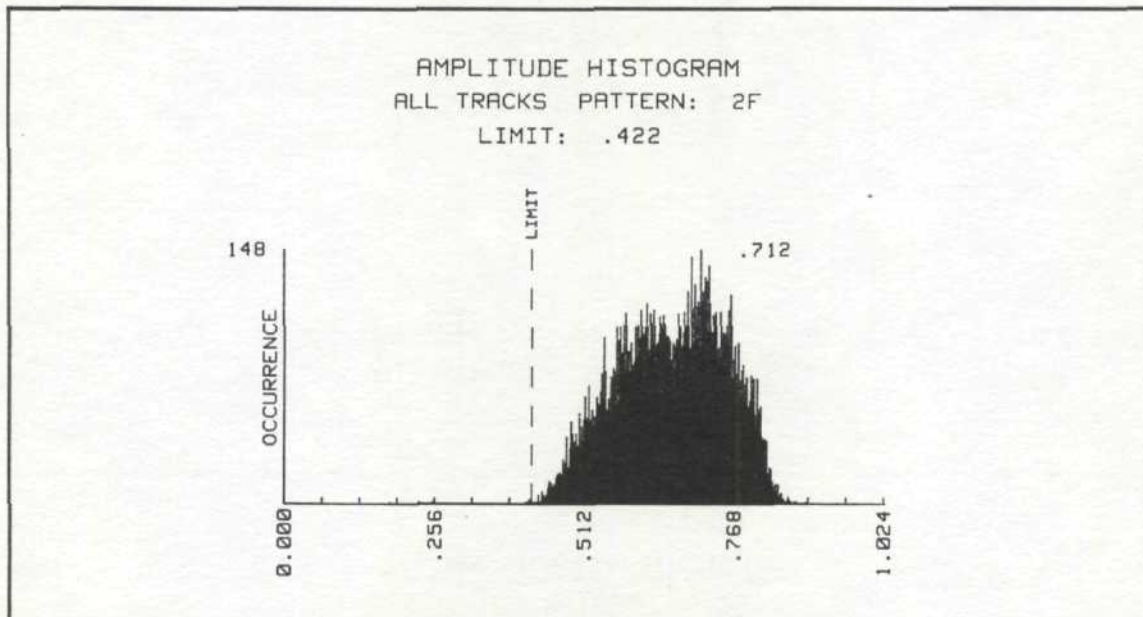

**Figure 11a,b** Sector/Amplitude Plots for un-burnished (figure 11a) and burnished (figure 11b) media. Each plot shows the average read amplitude for 32 consecutive sectors covering Tracks 15 and 16. Un-burnished media (a) is characterized by large sector voltage deviations over the two revolutions. The maximum deviation of average voltage over all sectors is 0.152V. The burnishing process improves particle orientation and reduces the sector-to-sector amplitude deviation to 0.128V (b).

## SURFACE HISTOGRAM—ALL TRACKS

A complete surface histogram is built by linking amplitude data from all sectors on one or both sides of the media. Overall performance measures for dispersion and polishing processes are obtained from the accumulated amplitude information. Defect mapping is accomplished by locating bitcell, sector, and track information for all transitions having peaks lower than the selected limit. When performing defect mapping it will be necessary to capture the read signal for all transitions in the data field. For process control, feedback in dispersion and polishing processes, a few peaks in each sector will be sufficient.

A complete surface plot based on averaging 32 peaks for each sector is presented in Figure 12. The counted burst timebase was set up identical to that for single sector and track tests 16 samples per peak with a sample period of 250 nsec per point. In all, 32 tracks at 16 sectors per track were tested (a total of 16384 peaks were cataloged in the histogram). The density function follows an asymmetrical shape and has a peak at .712 Volts.



**Figure 12.** Entire surface histogram representing amplitude density for 32 bitcells per sector, 16 sectors per track, and 32 tracks (16384 total bitcells). By extending the single sector and track histograms, the amplitude density algorithm keeps track, sector, and bitcell locations for any peak having an amplitude less than the set LIMIT (0.422V).

## Amplitude Density Model

Amplitude histograms become a useful analytical tool in measuring media performance if the shape of the density function can be described mathematically. A very common model for random amplitude fluctuations—the Rayleigh Density function—frequently appears in the study of signals transmitted through random media. Without insisting that the amplitude density function for disc signals follow the Rayleigh function, it is suggested that the data fits an asymmetrical density form like that of Rayleigh.

The Rayleigh probability density function for a random variable X is given by:

$$P(X) = \frac{X}{\beta^2} e^{-\frac{X^2}{2\beta^2}} \text{ for } X \geq 0$$

Where  $\beta$  is an adjustable shape factor.

It follows that the maximum value of the density function, indicating the most probable value for  $X$ , is located at  $X = \beta$ . Figure 13 is a normalized plot of the Rayleigh density function for two values of  $\beta$ .

The  $5\frac{1}{4}$ " amplitude histogram plots showed non-symmetric shapes when a statistically adequate number of peaks were cataloged, as in the case of the track and overall surface tests. It appears in most cases that the Rayleigh function should be reversed on the ordinate ( $X$ ) axis for best agreement. The probability function  $P(X)$  of Figure 13 is reversed on the  $X$  axis, becoming  $P(1-X)$ ; the normalized plot is shown in Figure 14 for  $\beta = 0.25$ .

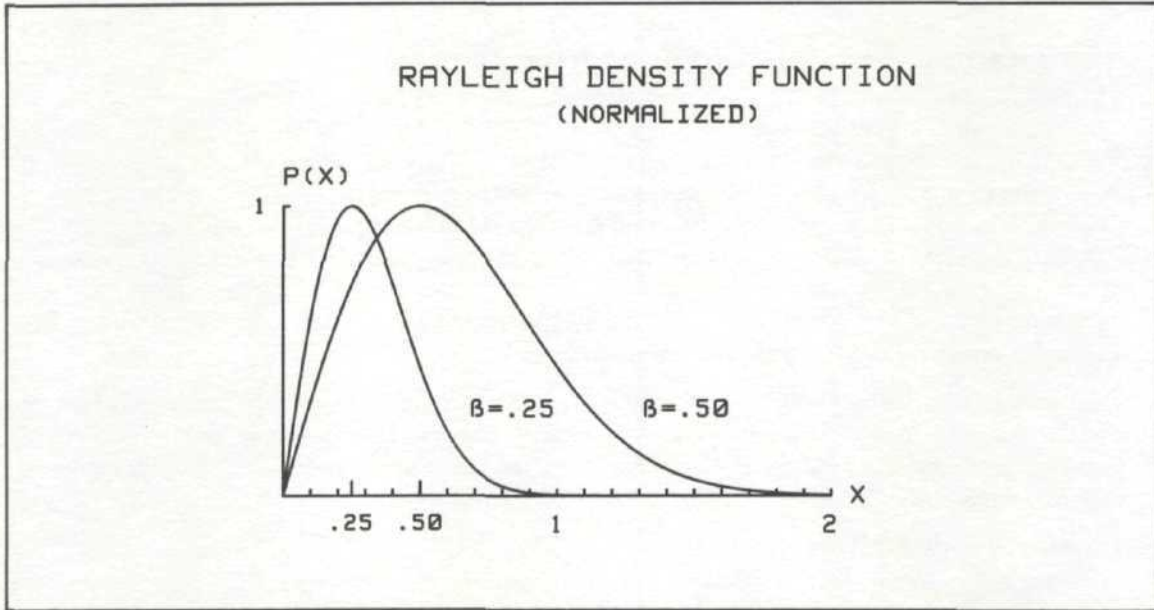

Figure 13. Normalized Rayleigh Density function  $P(X)$  for  $\beta = 0.25$  and  $0.50$ . The most probable value for  $X$  falls at  $X = \beta$ . Asymmetric density functions, like Rayleigh, may be used to describe amplitude density functions for captured read signals.

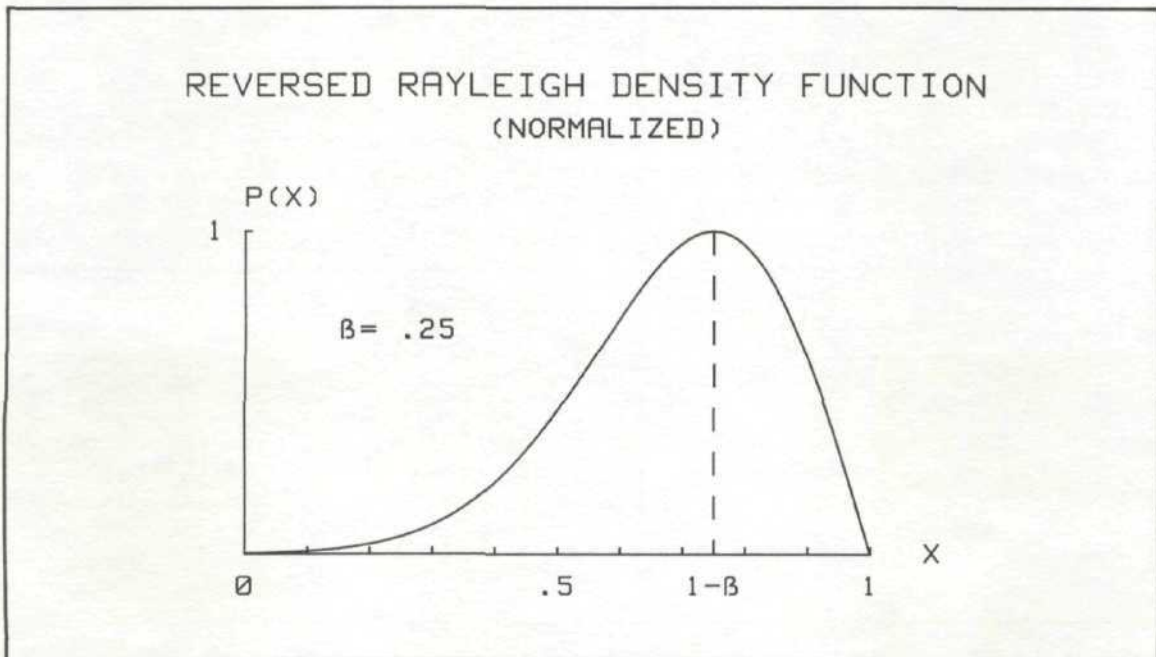

Figure 14. The reversed Rayleigh function more closely represents the density plots for entire surfaces (compare to Figure 12).

# ANALYSIS OF DISC DRIVE SIGNALS

Numerous electrical studies are required to design and produce high quality disc storage devices. Waveform recorders are well suited for analysis of a variety of disc signals because they are capable of capturing single-sector burst transients and they provide digital data which may be directly inspected using common dynamic signal processing algorithms.

Several time and frequency analysis techniques may be used to study raw and conditioned read recovery waveforms. Time and frequency domain test concepts are covered in separate sections; additional information for both may be found in the Appendix.

## Time Domain Analysis of Disc Drive Signals

The difficult operation of decoding serial digital data from a recovered analog signal requires controlling time relationships between two signals — a reference clock and a conditioned pulse waveform that represents the binary data stream. Synchronization of the two signals, data and clock, seems a simple task, since both are derived from the same analog signal. But higher bit packing densities complicate the magnetic storage model, making synchronization difficult. Specific mechanisms affecting crowded transition zones, particularly peak shift, pulse width, and pulse symmetry, need to be measured and controlled if an acceptable bit error rate (BER) is to be realized. The waveform recorder simplifies the investigation of these and other timing relationships by capturing real time waveforms and enabling time domain analysis for direct measures of performance.

Timing tests that gather information from the raw read recovery and conditioned data waveforms are presented. Raw read recovery waveforms come from the read head amplifier-filter chain, typically before the differentiator. Conditioned data waveforms are generally ECL or TTL logic sequences and are derived from analog signals using level or zero-cross detection.

### Analysis of Raw Read Waveforms

The amplified raw read signal may be captured and examined, either manually — using voltage and time cursors, or automatically — through waveform analysis, to determine isolated or crowded pulse parameters. Pulse characterization yields answers in numerous design and production test activities such as measuring the effect of pulse slimming networks, adjusting write pre-compensation and current to control peak shift, or estimating the head-media impulse response function.

Concepts and application examples for three general purpose read pulse analysis programs are to be presented. These include routines to measure the 50% pulse width, peak shift by comparing pulse rise times, and pulse symmetry by rise-time/fall-time comparison and integration.

### PW50 — THE PULSE WIDTH

An important time interval measurement, taken between 50% points on the rising and falling slopes of a read signal, is identified as PW50. This pulse width is a needed parameter used in packing factor calculations and helps measure the performance of shaping networks. Figure 15 shows amplified read pulses from a middle and inside track using the MFM ...010101... pattern, using a sample period of 50 nsec/sample. Inspection shows that the waveshapes are similar, with inner tracks having wider pulses.

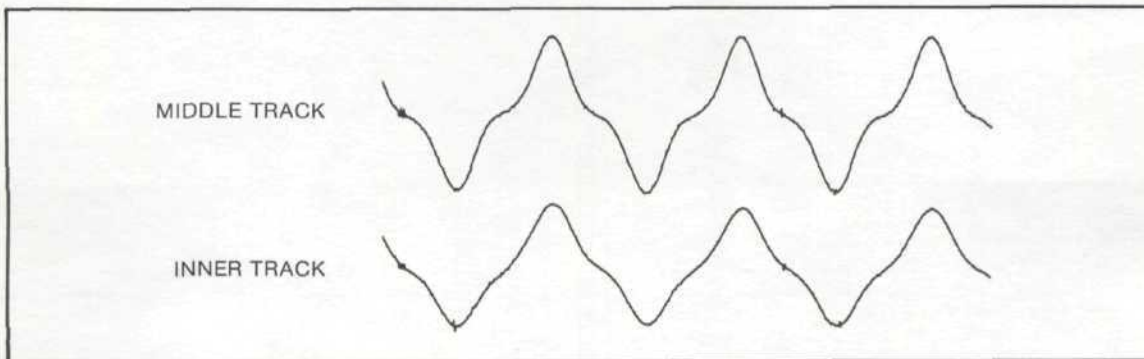
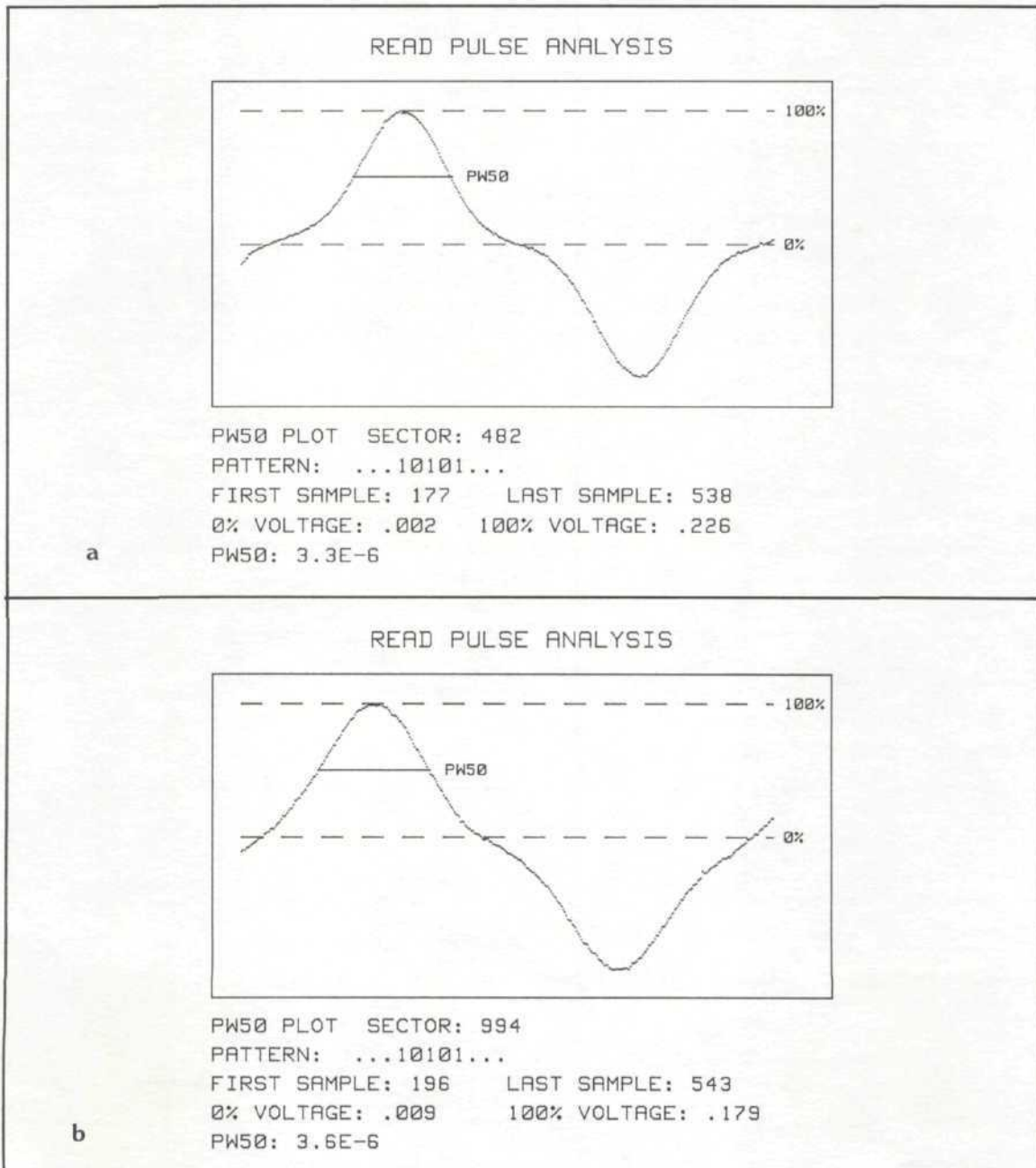

Figure 15. Amplified read pulses from a middle (upper trace) and inner (lower trace) track radius. MFM ... 010101 ... produces the 62.5 KHz signals shown. The two waveshapes are similar, with the inner tracks having wider pulses. Sample period was 50 nsec/sample; record length 1024 points.

The PW50 routine calculates the 50% pulse width for any pulse in the captured record; the operator identifies the pulse by positioning two 5180A cursors. The waveform data is transferred to the 9826 where a voltage distribution (histogram) is used to calculate the baseline (0% level) for the pulse. The baseline is defined by the mean of the voltage probability density function.\* The peak of the pulse is located and the 50% level calculated, where the 50% voltage is halfway between the base and peak. PW50 is the time interval between the two 50% points. PW50 plots for the two tracks shown in Figure 15 are shown in Figure 16a and 16b. The pulse pattern (MFM ...010101...) produces a 62.5KHz read signal with PW50 of 3.30 usec on the middle track (sector 482) and 3.60 usec on the inner track (sector 994). The time interval resolution is 50 nsec, since a sample interval of 50 nsec/point is used to capture the pulse.



**Figure 16a,b** Automatic PW50 calculations for the two waveforms shown in Figure 15. The PW50 middle track (sector 482) shown in (a) has PW50 = 3.30  $\mu$ sec. The inner track (sector 994) plot (b) has PW50 = 3.60  $\mu$ sec.

\*The voltage density technique for pulse analysis is based on IEEE Std 181-1977, **IEEE Standard on Pulse Measurement and Analysis by Objective Techniques.**

## PEAK SHIFT AND PULSE SYMMETRY

Physical interaction between densely-packed magnetic transitions cause detected voltage peaks to move apart and pulse shapes to become asymmetric. "Peak shift", "pulse spreading", and "bit shift" are common terms used to describe the phenomena. Designers need to characterize peak movement and pulse asymmetry to guarantee that, even for dense inner tracks, read transitions fall inside the bit detection windows.

A magnetic transition zone, when passed under a read head, produces a voltage pulse that has a 50% pulse width (PW50) longer than the magnetic transition zone length. The head-media impulse response determines the amount of pulse spread and degree of symmetry. Rise and fall times of an isolated read voltage pulse are usually unequal and produce the asymmetric shape. The location of a voltage peak, referenced to the magnetic transition, depends on write current, head flying height, recording radius, and the transition pattern written. Shift and symmetry is difficult to predict because the exact flux contribution of longitudinal and transverse magnetic remanence vectors makes it difficult to determine the transfer function (using the transition zone as input and read voltage as output). Shift and symmetry parameters may be determined by recording the amplified read signal and applying post-capture processing.

Calculating shift and symmetry parameters requires locating key points in the pulse—10% and 90% rise- and fall-time positions, the 0% baseline, and the 100% (peak) positions. The captured pulse is identified by placing cursors about the beginning and end pulse baselines (also used in the PW50 analysis). Peak shift will be determined by comparing pulse risetimes. Two measures of pulse symmetry will be introduced—one method compares rise- and fall-times of the half-pulse; the other calculates a quarter-pulse integral.

### PEAK SHIFT DETERMINED FROM RISE-TIME

Peak shift is identified by measuring a change in 10%-to-100% rise-times for half-pulses produced by two different test patterns. Figure 17 illustrates this definition. Different methods for determining shift may be applied depending on the drive's bit discrimination scheme. Discrimination is usually one of three methods—peak detection, level detection, or zero-crossing detection. The 10%-to-100% analysis method shown in Figure 17 is best suited for level and peak detecting systems because the voltage level that triggers the comparator may be easily located on the rising and falling slopes. It is much more difficult to locate zero-crossings because of noise in the pulse base-line. The next section, "Analysis of Conditioned Data Streams", explains a method for determining edge-to-edge time intervals for the conditioned data signal and is well-suited for all three types of bit discrimination. The conditioned data signal is the read recovery signal after it has passed through the analog comparator.

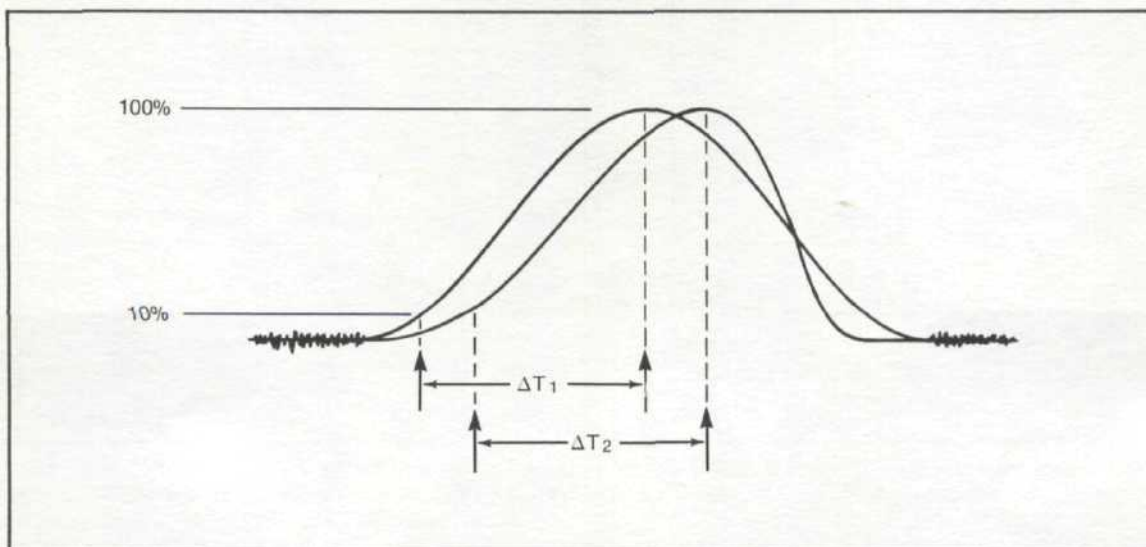

Figure 17. Peak shift may be identified by comparing 10%-100% rise-times for two different test patterns.

Pulse rise-time plots for two sectors on track 31 are shown in Figures 18a and 18b. Using the 10% rising edge location as a reference, the location of the peak is 1.85  $\mu\text{sec}$  for the MFM ..000000... 2F pattern (Figure 18a). The captured pulse in Figure 18b represents the 1-1 data transition; the half pulse width should be the same as for a 0-0 transition. The rise-time difference for the 1-1 and 0-0 pulses indicates the amount of pattern-induced peak shift. A peak-detecting discriminator would locate the peak in Figure 18b 800 nsec later than the peak in Figure 18a. By capturing and processing the raw read signal, the source of bit shift is analyzed, independent of the effects of comparator or phase lock drift.

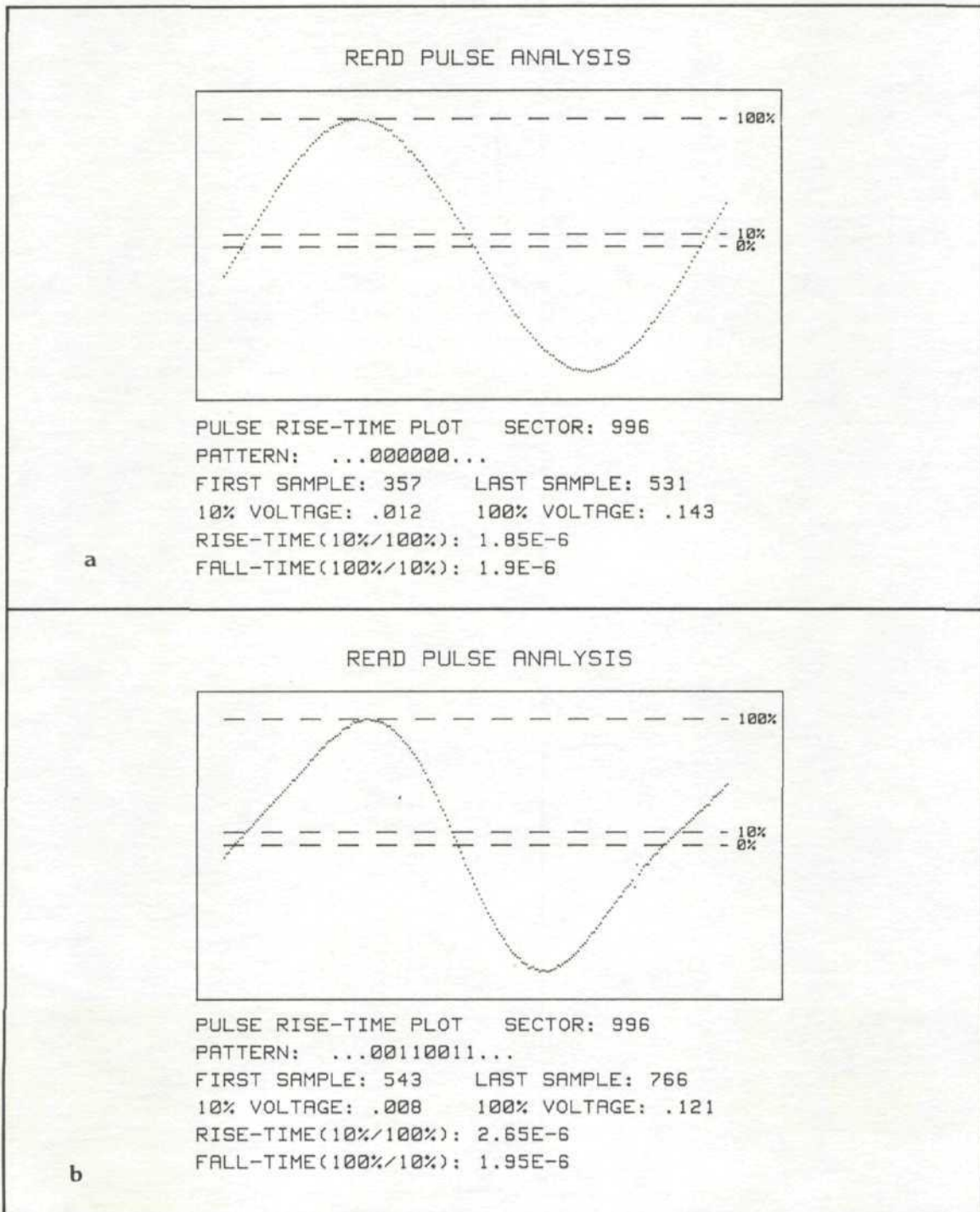

Figure 18a,b. Pulse rise-time plots for two MFM patterns on sector 996. The MFM all zeros (2F) pattern has a risetime of 1.85  $\mu\text{sec}$  (a). The 1-1 data transition (b) should have the same half-pulse width as a 0-0 transition, therefore nearly the same risetime. Risetime in (b) for MFM ...00110011... is 2.65  $\mu\text{sec}$ , which is 800 nsec longer than the risetime in (a). Up to 800 nsec of shift could result if a peak-detecting discriminator is used to decode the data.

## PULSE SYMMETRY

Pulse symmetry, as a quantity of measure lacks formal definition, but may be represented using two comparisons—half-pulse rise-time to fall-time (Figure 19a), and first-quarter to second-quarter integral area (Figure 19b). The rise-time routine used in the peak shift calculation also displays fall-time. Again refer to Figure 18b. A comparison of the two times represents the degree of pulse symmetry (rise-time:  $2.65 \mu\text{sec}$ , fall time:  $1.95 \mu\text{sec}$ ). A half-pulse having better symmetry would have rise-time more equal to its fall-time.

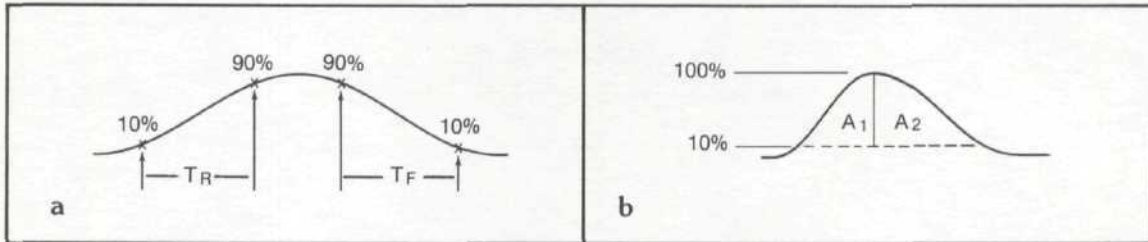

Figure 19a,b. Symmetry may be represented by comparing pulse rise- and fall-times (a) on quarter-pulse areas (b).

The second measure of symmetry is based on waveform integration, where a comparison of first-quarter and second-quarter areas is made. The two 10% voltage points and 100% peak location divides the pulse for integration. The Trapezoid Rule calculates the pulse areas and presents a ratio  $A1/A2$ , where  $A1$  and  $A2$  are the first and second quarter-pulse areas, respectively. The pulse symmetry plot, Figure 20a, gives area ratios for the pulse that was shown in Figure 18b. The  $A1/A2$  ratio of 0.571 indicates

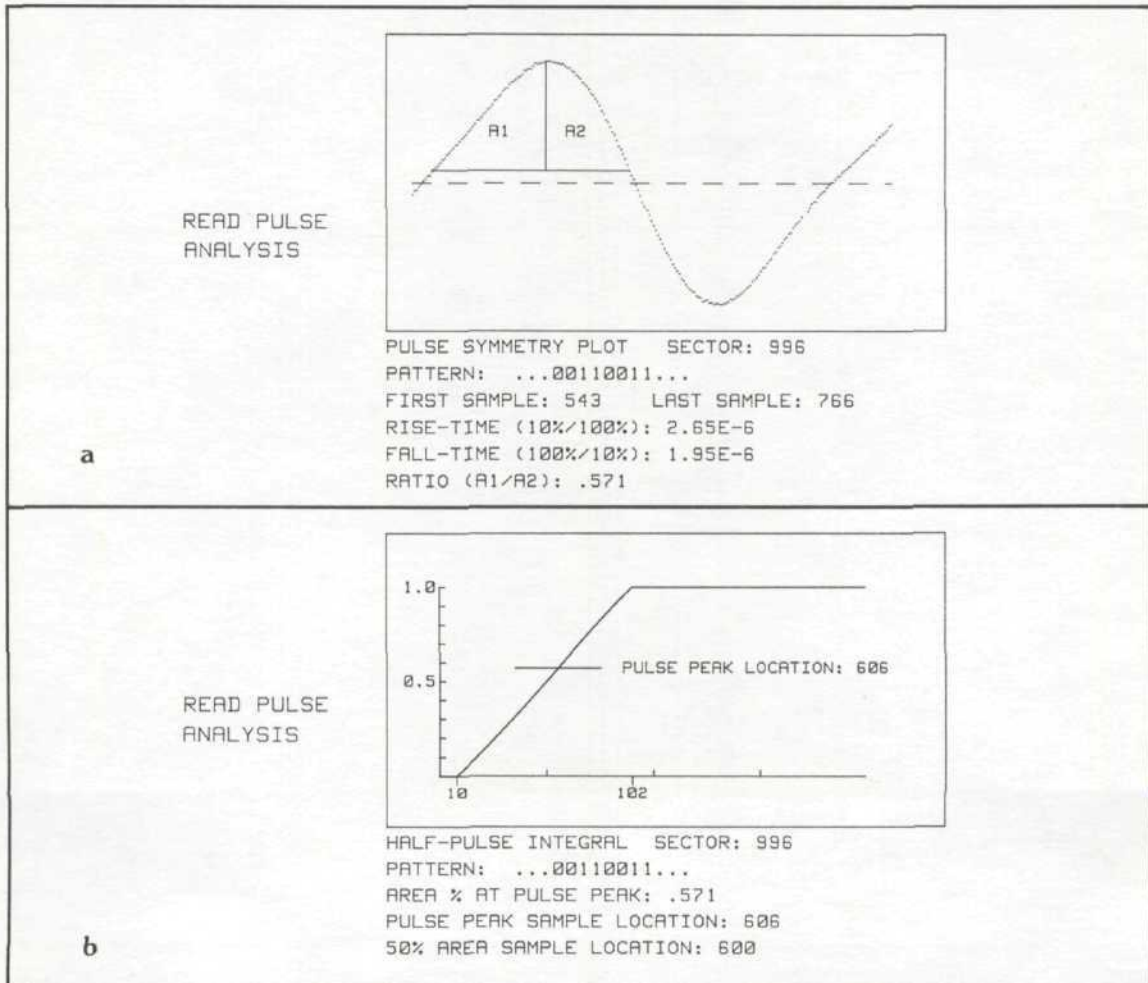

Figure 20a,b. Quarter-pulse areas are computed by integrating the half-pulse from 10% to 100%. The ratio of  $A1$  to  $A2$  (a) is .571, indicating that the pulse peak is "smeared" to the right. A normalized integral plot (b) of the data in (a) shows how area is accumulated over the half-pulse. The 50% area is 6 samples later than center.



that the pulse is "smeared" to the right; also obvious by inspection. Rise-time and fall-time values are given in the symmetry plot of Figure 20a along with the area ratios to provide both measures of symmetry. To learn how area is accumulated over the half-pulse, a normalized integral plot is produced (Figure 20b). The pulse voltage peak is identified slightly greater than the 50% area (0.571%) and is 6 samples later than center.

Automatic calculation of PW50, shift, and symmetry parameters provides information needed in the evaluation of the read recovery chain, allowing optimization of the packing factor for a given head-media combination. The prime measurement benefit offered by the waveform recorder is the capability to capture the analog waveform and make the data available for analysis. A design engineer is able to make visual inspections of pulse parameters or standardize the measurement using the automatic methods described, reducing the risk of measurement error.

### **Analysis of Conditioned Data Streams**

Time domain analysis of conditioned data streams assures the quality of the read recovery process by revealing pulse width deviations at the output of the analog comparator and measuring the synchronization of data and clock signals. Two time interval tests gather and plot statistics for conditioned pulses—a comparator output pulse width histogram and a data-clock time margin histogram.

### **PULSE WIDTH HISTOGRAMS**

The read waveform passes through the detection comparator circuit and is changed into a pulse waveform that has a predictable duty cycle. For example, the MFM 2F pattern for the 5¼" drive results in a square wave pulse stream (50% duty cycle) with a half-pulse period of 4  $\mu$ sec. Random digital data can produce three half-cycle pulse widths—4, 6 and 8  $\mu$ sec. Changes in spindle speed, peak shift, and threshold drift in the bit detection circuit cause half-pulse widths to deviate about the expected values. A time interval histogram, based on the accumulation of half-pulse time interval widths, may be used to evaluate shift pre-compensation, write current level, phase locking, and other measures used to improve data/clock synchronization.

The pulse width test routine takes a series of captured pulses, locates the first and last edges, and determines all half-pulse time intervals. In an intermediate step, two voltage probability density histograms are computed to determine baseline and topline voltage bands that are needed in the edge sorting subroutine.\* Voltage histograms assist in locating baselines and toplines in the presence of noise, and do take additional time to compute. They may be omitted if threshold voltage levels for the pulse edges are entered into the program.

\*The voltage density technique for pulse analysis is based on IEEE Std 181-1977, **IEEE Standard on Pulse Measurement and Analysis by Objective Techniques**.

The pulse waveform of Figure 21 is the captured comparator output following the differentiator in the 5¼" floppy read recovery chain (Sector 21, MFM Pattern: 1011001100110010). The waveform contains half-pulse widths of 4, 6, and 8 μsec. Figures 22a and 22b show the baseline and topline voltage density histograms, respectively. Baseline voltage is 0.290 with a base-band level of 0.350 V. Top line voltage is 4.96 with top-band at 4.410 V. The two histograms show the importance of determining baseline and topline voltage bands for edge location. The width of the histogram shows that there are voltages to either side of the baseline and topline averages that may trigger false edge location, hence an incorrect time interval, if a trigger band is not imposed.

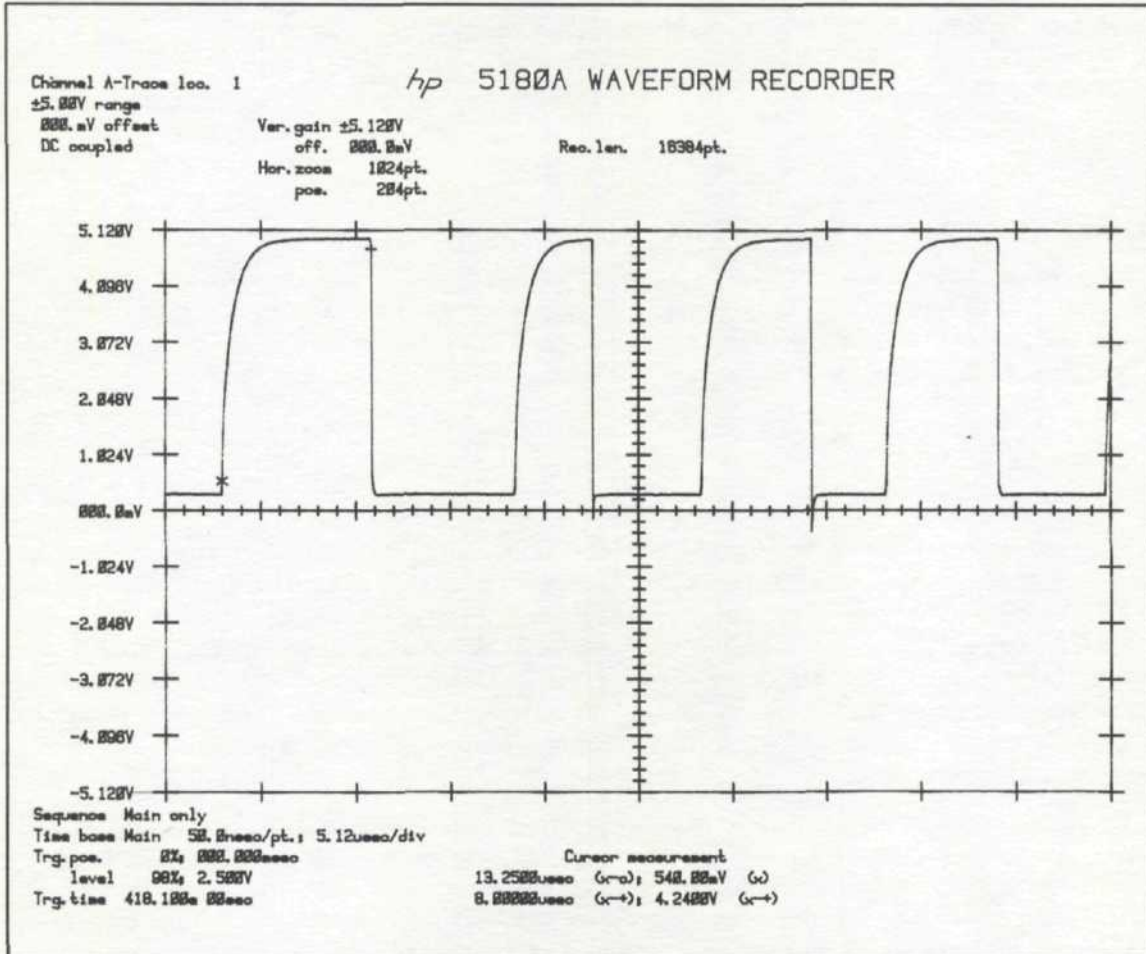
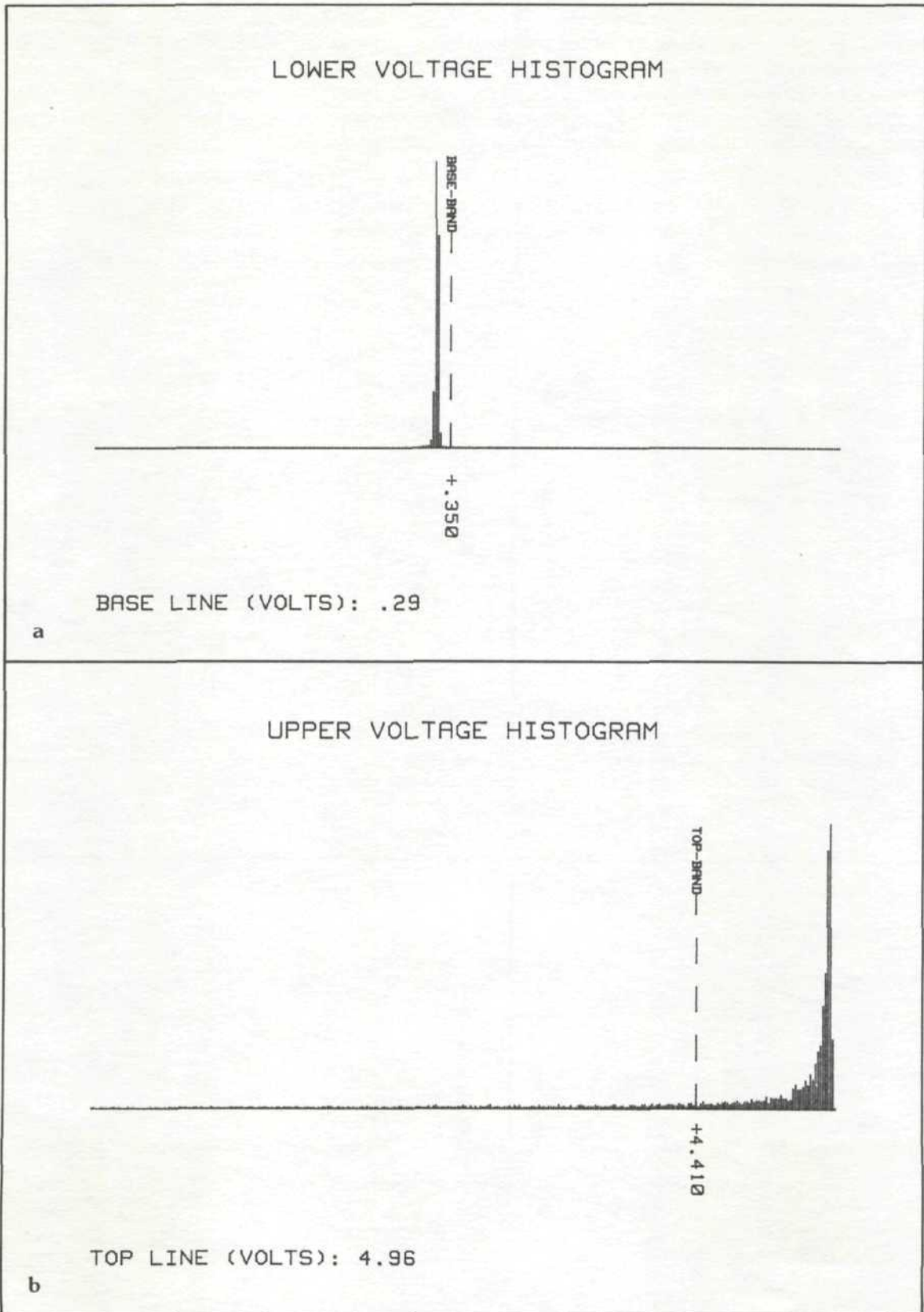

Figure 21. Comparator output waveform for MFM pattern 1011001100110010, having half-pulse widths of 4, 6, and 8 μsec.



**Figure 22a,b.** Voltage histograms for pulse baselines (a) and toplines (b) are used to calculate trigger levels for edge location in the pulse width histogram test. The mean of the lower histogram is .290 Volts, with base-band of 0.350 V. A rising edge is located where the waveform passes through the base-band. A falling edge is identified where the waveform passes through the top-band, 4.410V (b). Automatic calculation of the base and top bands reduces the probability of false edge triggering because of topline or baseline noise.

A 5180A record of 16384 samples, taken at 50 nsec/sample, provides 140 edges for the test pattern used. The time interval histogram for the complete record is shown in Figure 23. The three pulse width distributions at 4, 6, and 8  $\mu$ sec used are calculated with 50 nsec resolution. It is seen that the 4  $\mu$ sec pulses are slightly wide, the 6  $\mu$ sec narrow, and the 8  $\mu$ sec narrow. The same pattern tested for sector 1023 (inner track) shows the 4  $\mu$ sec pulses even wider (4.25  $\mu$ sec), the 6  $\mu$ sec about the same, and the 8  $\mu$ sec pulses about the same width, but with more deviation (Figure 24).

The automatic calculation of consecutive time intervals for conditioned data streams enables the test or design engineer to measure read recovery performance quicker, with better results. Since each histogram is based on a large number of transitions, statistics are improved.

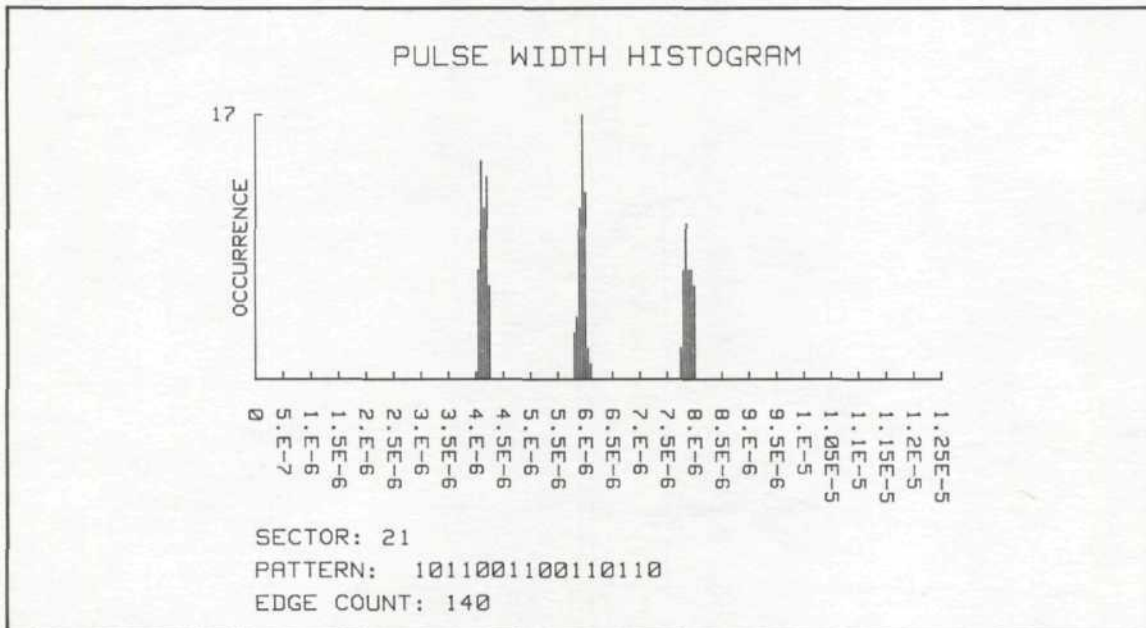

Figure 23. Pulse width histogram for MFM pattern 1011001100110010 section 21 showing distributions at 4, 6, and 8  $\mu$ sec. The deviation is 250 nsec for the 4 and 8  $\mu$ sec widths and 300 nsec for the 6  $\mu$ sec width.

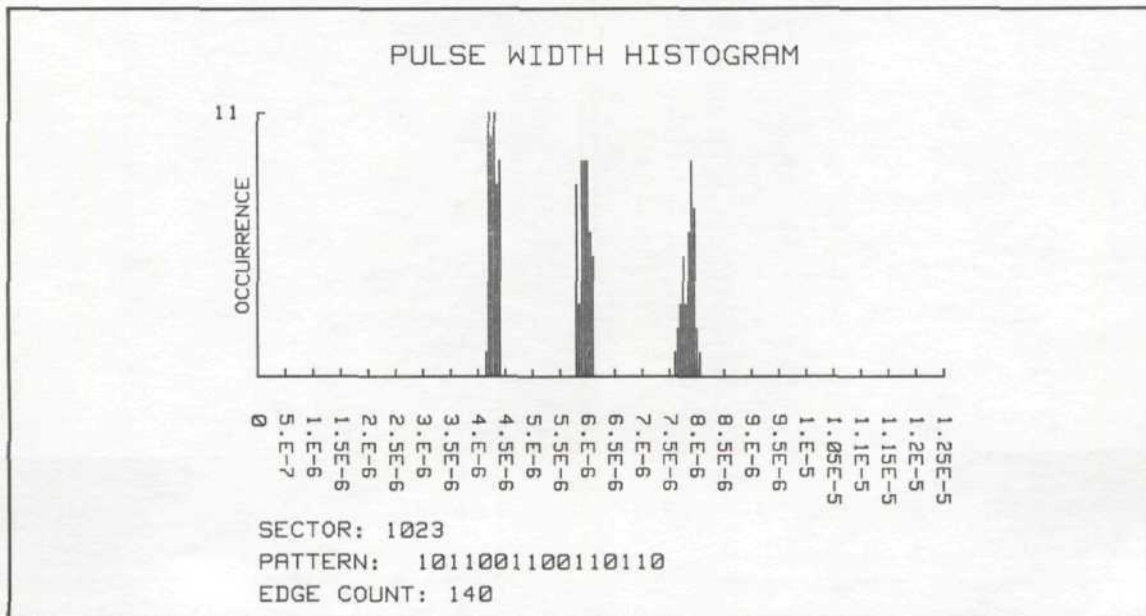

Figure 24. The same MFM pattern used in Figure 23 is written to an inner radius track (sector 1023), producing the pulse width histogram shown. The 8  $\mu$ sec deviation is wider (450 nsec) than the 8  $\mu$ sec deviation for an outer radius track (250 nsec, shown in Figure 23).

## DATA-CLOCK TIME MARGIN ANALYSIS

Error free data recovery, assuming defect-free media, depends on establishing precise timing relationships between clock and data transitions. The disc controller uses clock edges to generate cell boundaries for one-zero decoding of the read data (RDATA) waveform. Modern disc storage methods use "self clocking" codes, where one recorded waveform contains information for recovering both data and clocking signals. Read-clock (RCLK) is usually implemented using a phase-locked loop (PLL) which is locked to a series of "sync bytes" located immediately before the sector data field. The PLL adequately tracks small timing fluctuations through the read process. Significant random and steady state influences, however, tend to alter synchronization and hence, directly affect bit error rate. The time margin test routine is an analytical tool that provides measures of peak shift, read recovery phase lock performance, and effect of active shift pre-compensation.

The 5180A is used to capture and examine time interval relationships between read-data (RDATA) and read-clock (RCLK) waveforms. The Time Margin test accumulates time interval measurements for each bitcell and displays results in a time margin plot. Test examples for the 5 $\frac{1}{4}$ " floppy are given.

### RCLK AND RDATA TIMING FOR MFM DATA PATTERNS

To help understand synchronization, MFM timing relationships for RDATA and RCLK are presented in Figure 25. The MFM all zero's pattern (2F) has a RDATA transition in each first half-cell (the first half-cell is defined by the negative half cycle of the RCLK waveform and is 2 $\mu$ sec wide). Ideally, all RDATA edges should fall in the center of each RCLK first half-cell.

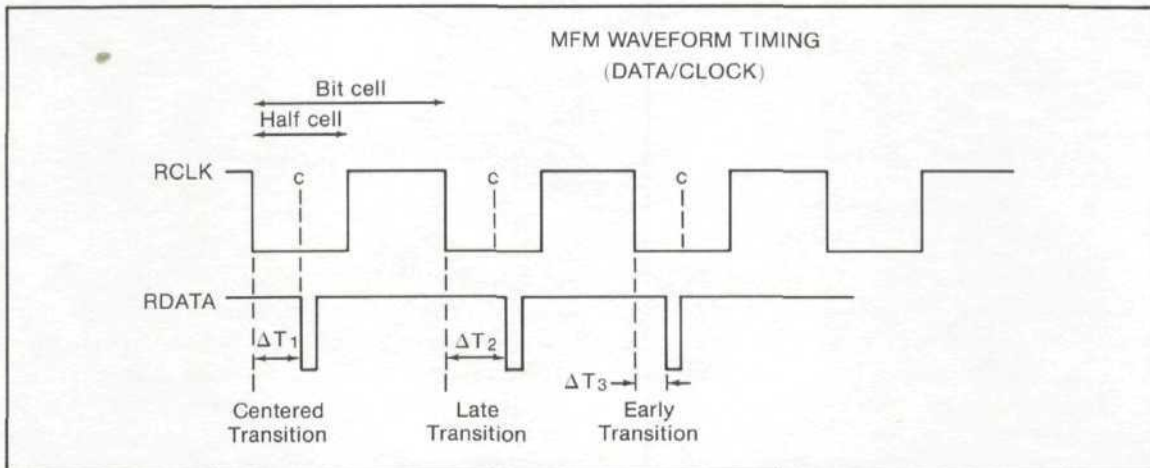

Figure 25. MFM timing relationships for RDATA and RCLK using the all zeros (2F) pattern. Perfect synchronization places the leading edge of RDATA in the center of the RCLK first half cell.

### CAPTURE TECHNIQUE—TIME MARGIN TESTING

The time margin routine calculates the start-stop, edge-to-edge time interval for each bitcell having a RDATA transition using RCLK as a **start** signal and RDATA as a **stop** signal. Clearly, both RDATA and RCLK waveforms could be captured and processed to find the timing for several consecutive bitcells. Since both waveforms are required, the 5180A's 16K memory could be divided, allowing 8K for each. This limits the number of bitcells that can be tested and increases the amount of data to be processed. An application of counted burst timebase, presented in "Amplitude Histogram Tests," eliminates the need to capture both RDATA and RCLK and doubles the number of bitcells that may be tested while reducing processing time.

A counted burst timebase from the 8112A Pulse Generator digitizes RDATA pulse streams while maintaining timing reference to RCLK edges. The trigger input to the 8112A is the RCLK signal; its output is used to drive the 5180A digitizer. The RDATA signal is input to the 5180A's A Channel. Each RCLK edge, negative- or positive-going depending on selected slope, triggers the pulse generator which then clocks the 5180A digitizer exactly N times. The RDATA signal is captured during the burst period (burst period is determined by pulse generator parameters and is equal to the number of pulses (N) times a pulse period of 50 nsec). Selective pulse studies are made possible because the

burst generator may be triggered on either RCLK slope, allowing time interval measurements in either the first or second RCLK halfcell. This example uses negative slope trigger and shows RDATA and RCLK timing relationships for the negative going RCLK halfcell. Figure 26 is a burst timing diagram used for time margin testing.

RDATA edges for perfectly synchronized transitions fall in the middle of the first half-cell ( $1\mu\text{sec}$  from the negative going RCLK edge). A sum of random and systematic influences cause RDATA to deviate about the half-cell center. To cover the  $2\mu\text{sec}$  "window" each first half-cell is digitized using 40 samples separated by 50 nsec each. Since each bitcell needs 40 samples, the 5180A's 16K memory (16384 words) may cover up to 409 bits. The capture and time interval sort routines may use repetitive sector reads to gather more edges and improve statistics.

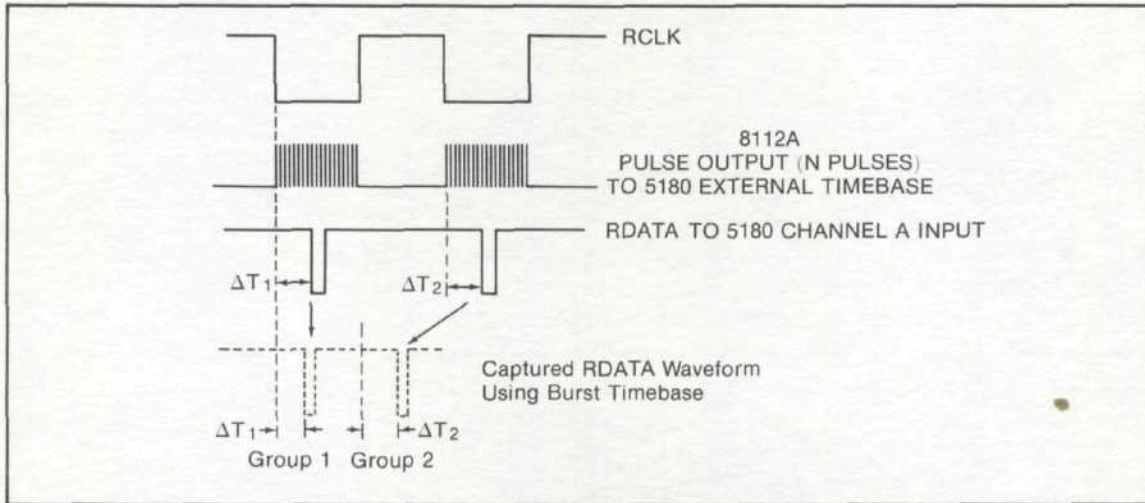

**Figure 26.** Burst timebase capture technique for Time Margin testing. The falling edge of RCLK triggers the 8112A Pulse Generator, causing it to output a counted number of pulses. The generator output clocks the 5180A digitizer N times, and records the RDATA edge for the RCLK first half cell.

The MFM 2F test pattern produces the time-margin histogram shown in Figure 27. The histogram shows two peaks, one at 950 nsec, the other at  $1.05\mu\text{sec}$ . Bimodal timing distributions indicate that RDATA edges tend to be early or late, but not centered, and can be attributed to locking performance of the PLL that generates RCLK. The base width of the histogram (200 nsec) shows the time "margin" between the extreme edge locations and the RCLK first half-cell boundaries. The earliest transition in Figure 27 comes at 900 nsec leaving a margin of 900 nsec. The latest transition is at  $1.1\mu\text{sec}$ , also with

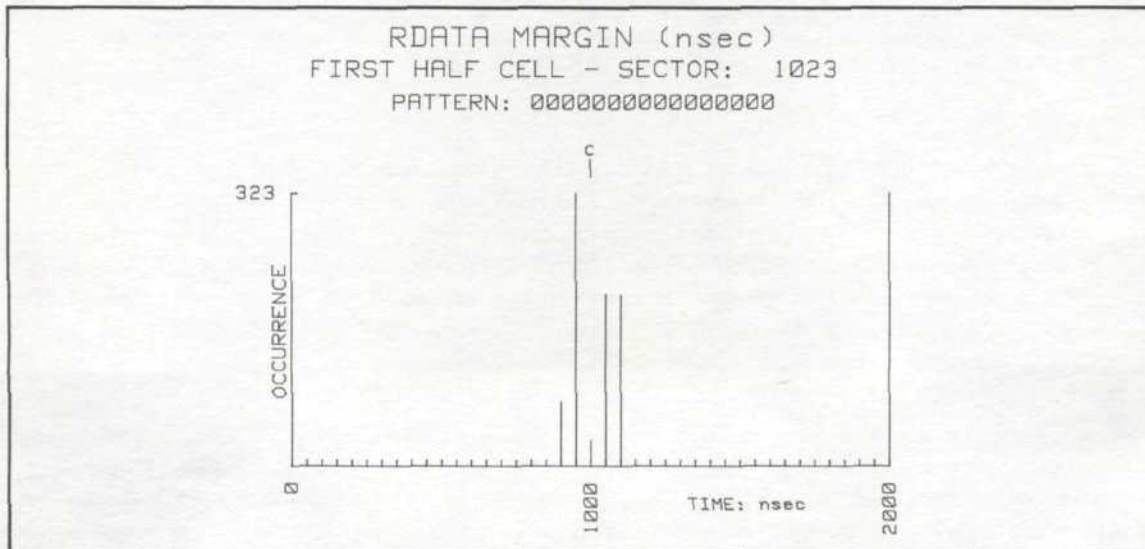

**Figure 27.** Time Margin Histogram for sector 1023, MFM 2F pattern. Time margin is 900 nsec, meaning that no transition in the captured record is closer than 900 nsec to either the beginning or end of the  $2\mu\text{sec}$  RCLK first half cell. The plot represents 650 first half cell transitions.

a margin of 900 nsec. The MFM 2F pattern usually results in better read recovery, and a narrower histogram, because the period of each cycle of the analog read waveform is approximately the same ( $8\mu\text{sec}$ ). MFM patterns that create analog read waveforms of several periods (8, 12, or  $16\mu\text{sec}$ ) produce wider time-margin histograms, and are more difficult to recover. Figures 28a and 28b demonstrate the reduced time margin, track dependency, and bimodal nature of a more random data pattern (MFM (MFM 0111001100011100)). The outer track (sector 85) shows bimodal timing with peaks at 850 nsec and  $1.1\mu\text{sec}$  and a histogram base width of 450 nsec. The inner track (sector 1023) shows similar bimodal timing with peaks at 800 nsec and  $1.2\mu\text{sec}$ , but with more histogram base spread (600 nsec). The wider histogram plots shown in Figures 28a and 28b point out that read recovery is more difficult for inner tracks and particular random test patterns.

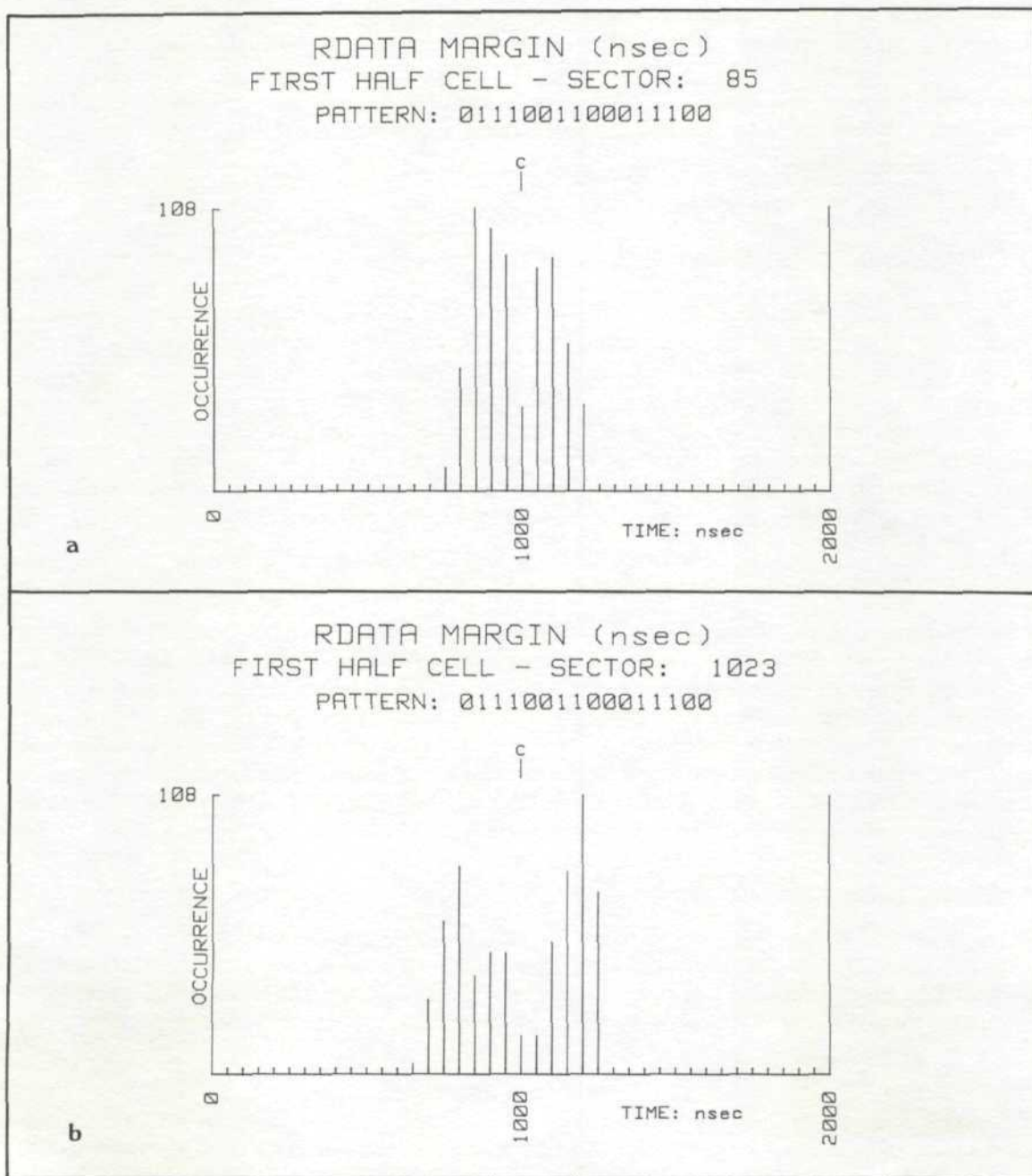

**Figure 28a,b.** Time Margin Histogram plots for a MFM pattern that produces read waveform periods of 8, 12 and  $16\mu\text{sec}$ . Compared to MFM 2F (Figure 27) the histogram plots here are wider, showing less margin. The plot of (a) is for an outer radius track and has a width of 450 nsec. The inner radius track (b) has more spread in the histogram (600 nsec). The wider histograms indicate that read recovery will be more difficult for particular patterns and inner radius track locations.

The time margin test provides the best indication of data and clock synchronization by directly measuring time intervals between RDATA and RCLK, as is done by the disc controller during read recovery. The histogram data demonstrates the effects of pattern induced peak shift, and may be used to adjust write current and monitor pre-compensation performance.

## Frequency Domain Analysis of Disc Drive Signals

The Fast Fourier Transform (FFT) is a widely used digital signal processing algorithm that is based on an efficient calculation of the Discrete Fourier Transform. The FFT calculates magnitude and phase of each frequency component for a block of time domain samples representing an input signal. A power spectrum plot, showing relative signal power for frequency components across a specified band, may be used in disc testing to evaluate spectral components of the analog read signal. Common investigations, sometimes performed using a spectrum analyzer, may be implemented using the 5180A's captured time domain data and FFT algorithms. Digitizing and post-processing simplifies frequency domain measurements because the 5180A may be triggered to capture selected intervals in a sector burst; a very difficult procedure when done with a swept spectrum analyzer.

In disc testing, the FFT tests may be applied to investigate system and media noise, pattern overwrite interference, and cross talk from adjacent or flip-side data and servo tracks.

### FFT Power Spectrum Algorithm

The 5180A's high performance 10 bit ADC provides FFT testing with a dynamic range of approximately 60dB\*. The basic FFT algorithm, usually applied to a data block size (N) of 1024 points provides N/2 spectral lines over a frequency range from DC to  $F_s/2$ , where  $F_s$  is the sample rate used to capture the read waveform (sample period is  $1/F_s$  sec/sample). Each spectral line represents the signal power in a bandwidth of  $F_s/N$ , centered at the frequency for that line. For signals that are perfectly periodic in the time record the "frequency resolution" of the FFT is  $F_s/N$ . Generally, captured disc signals will result in time records that contain a non-integral number of cycles (not periodic in the time record) and must be pre-processed using "windowing" to prevent unwanted distortion in the FFT plot.

The frequency resolution and frequency coverage for FFT tests depends on sample rate ( $F_s$ ), data block size (N), and type of window applied.

The frequency domain tests applied to the 5 $\frac{1}{4}$ " floppy drive use a block size (N) of 1024 samples and produce 512 magnitude and 512 phase components over a frequency range of DC to  $F_s/2$ . Occasionally there may be requirements to measure signals that are spaced closer than the frequency resolution provided by  $F_s/N$ , while maintaining a high sample rate ( $F_s$ ). Band selectable analysis techniques, sometimes called frequency "zooming", add the capability of increased resolution and are covered in HP Application Note 243 "The Fundamentals of Signal Analysis". Useful window shapes that improve FFT results are covered in publication number 02-5952-0705, "Compilation of Time Windows and Line Shapes for Fourier Analysis".

### Pattern Overwrite and Crosstalk Tests

The general FFT algorithm may be applied to study interference coming from overwritten bit patterns and crosstalk coming from adjacent data tracks or servo positioning circuits. The magnitude spectrum plot provides signal-to-signal power ratios for worst case test patterns, providing additional information used in calculating a drive's total error budget.

#### PATTERN OVERWRITE TESTS

Most disc systems directly overwrite old data with new and do not incorporate direct electronic erasure in the process. It is therefore necessary to determine the signal level of the overwritten remanence pattern in the presence of the new pattern. The FFT algorithm provides a straightforward method to measure overwrite by allowing a comparison of signal powers for new and overwritten data. A series of

\*The 5180A Data Sheet Specifications detail dynamic performance for the A, B, and AUX channels. Specifications directly affecting FFT results are DFT-Spurious and S/N Ratio.



tests applied to the 5¼" floppy drive serves as an example of FFT overwrite testing using the MFM 1F (...010101..) and 2F (...000000...) test patterns. The expected fundamental for 1F is 62.5 KHz with a high third harmonic at 187.5 KHz. MFM 2F produces a fundamental at 125 KHz with a small third harmonic.

Overwrite tests are based on a comparison of power spectrum plots for specific test patterns. The test begins with DC erasure of a particular sector. If DC erasure is not possible, the control pattern (for example 2F) may be written several times to insure complete overwrite of previously stored data. The first power plot produced is used as a reference and shows the 2F spectrum in the presence of system and media noise. The subsequent power plots show the spectrums of the newly written and overwritten patterns.

The overwrite test routine allows time record averaging, where a single sector read operation is performed several times. On each read operation, the read waveform is captured and is time-record averaged with previous data to improve the signal-to-noise ratio of the measurement.

To reduce distortion in the FFT, a P301\* window multiplies the time record before the FFT processing. The P301 window is a band-pass digital filter characterized by a pass-band width of 8 ( $F_s/N$ ) and good stop band attenuation (-70dB). It is well suited for overwrite testing because it offers exceptional amplitude accuracy (.05%). A well known window, Hanning, has poor amplitude accuracy (15%) but has a pass-band width of 4 ( $F_s/N$ ). The Hanning window is better suited for locating noise components, where frequency resolution is more important. The overwrite test sequence applied to the 5¼" drive uses the P301 window, however an additional plot is produced using Hanning to show effects of windowing.

Figure 29 is the 2F control spectrum plot for the test sequence and is based on the average of two time records. The sample period used is 500 nsec/point and the block size is 1024 points. The FFT produces 512 spectral lines from DC to 1MHz ( $F_s/2$ ), however the plot displays lines from DC to  $F_s/8$  or 250 KHz. An inspection of the plot shows that, except for DC, most spectral components are greater than 50dB below the 2F 125KHz fundamental.

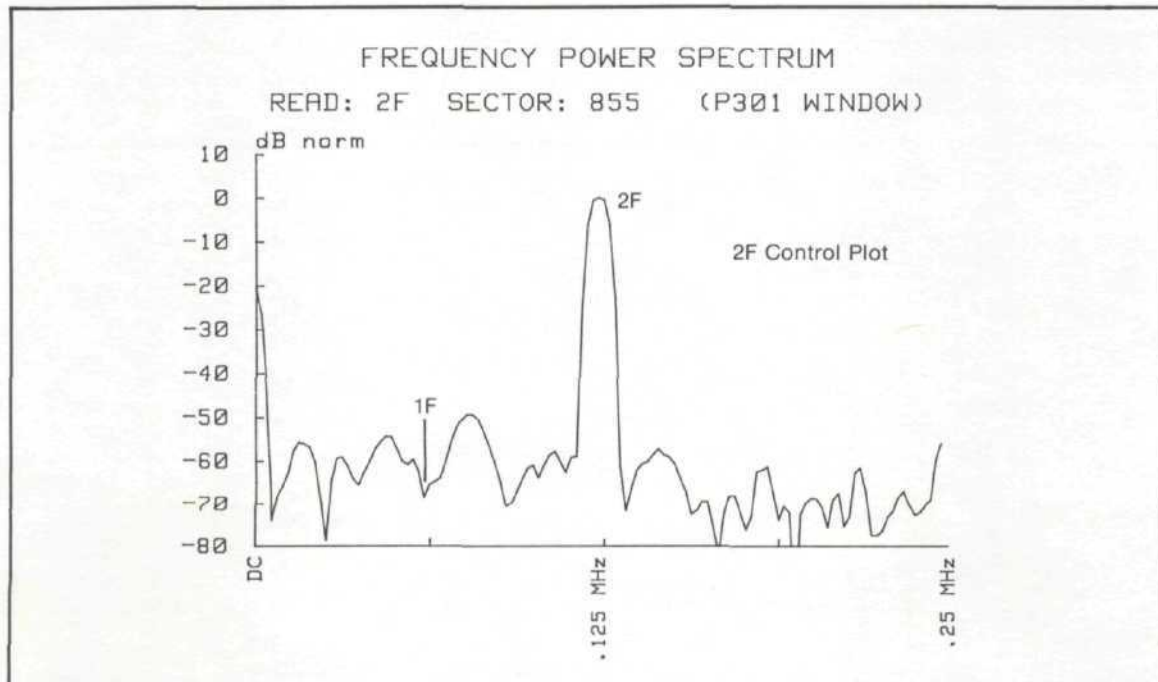

Figure 29. Power Spectrum plot for the 2F control pattern used in overwrite testing. The 2F fundamental at 125 KHz is taken as 0dB. Most other components, including the 1F fundamental at 62.5 KHz are greater than 50dB down.

\*The P301 and Hanning windows are completely described in publication number 02-5952-0705, "Compilation of Time Windows for Fourier Analysis". A tutorial on windowing to improve FFT results may be found in Application Note 243, "The Fundamentals of Signal Analysis".

To find the 2F remanence, a 1F pattern is overwritten and the FFT is again performed. Figure 30 shows the 1F over 2F spectrum. The 2F fundamental (125 KHz) has been reduced and is down 42 dB relative to the 1F fundamental (62.5 KHz). The high 3rd harmonic for the 1F pattern is noted at -19dB.

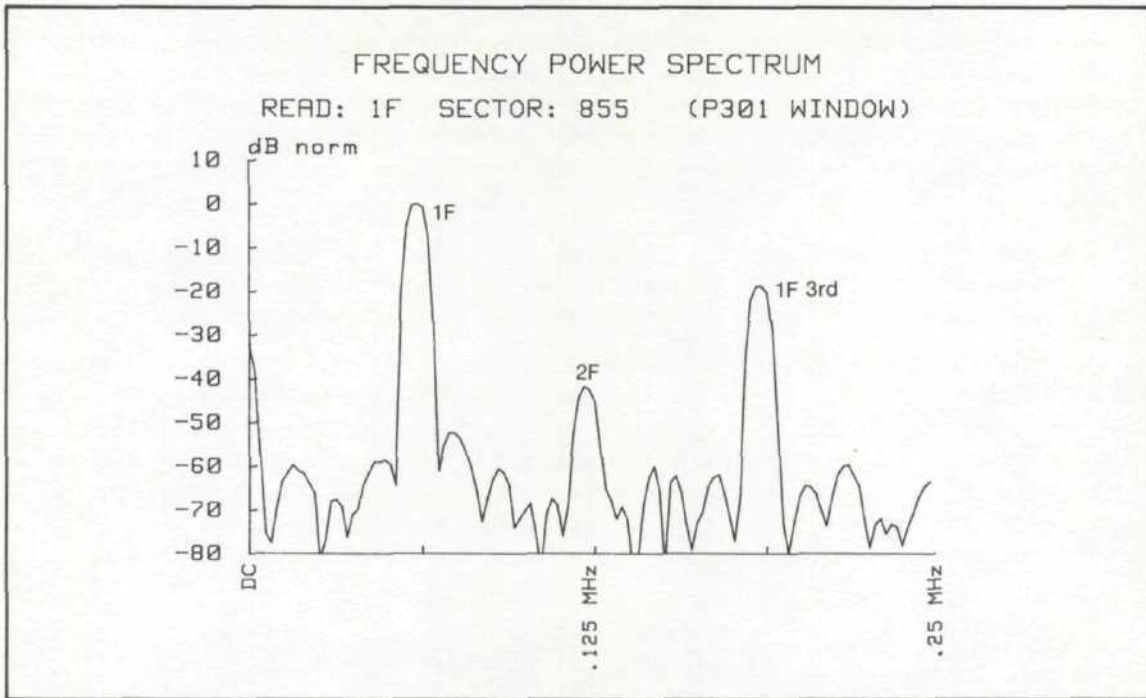

Figure 30. Power Spectrum for 1F overwrite 2F. The 2F fundamental has been reduced 42dB relative to the 1F fundamental at 62.5KHz are greater than 50dB down.

The pattern is again reversed by writing 2F over 1F. Figure 31 is the new spectrum showing the 62.5 KHz 1F component reduced to -42dB and its 3rd harmonic reduced to -45dB. Figure 32 shows another 2F overwrite 1F plot using the Hanning window. Signal components are more sharply defined, allowing easy identification of signals not related to the MFM patterns.

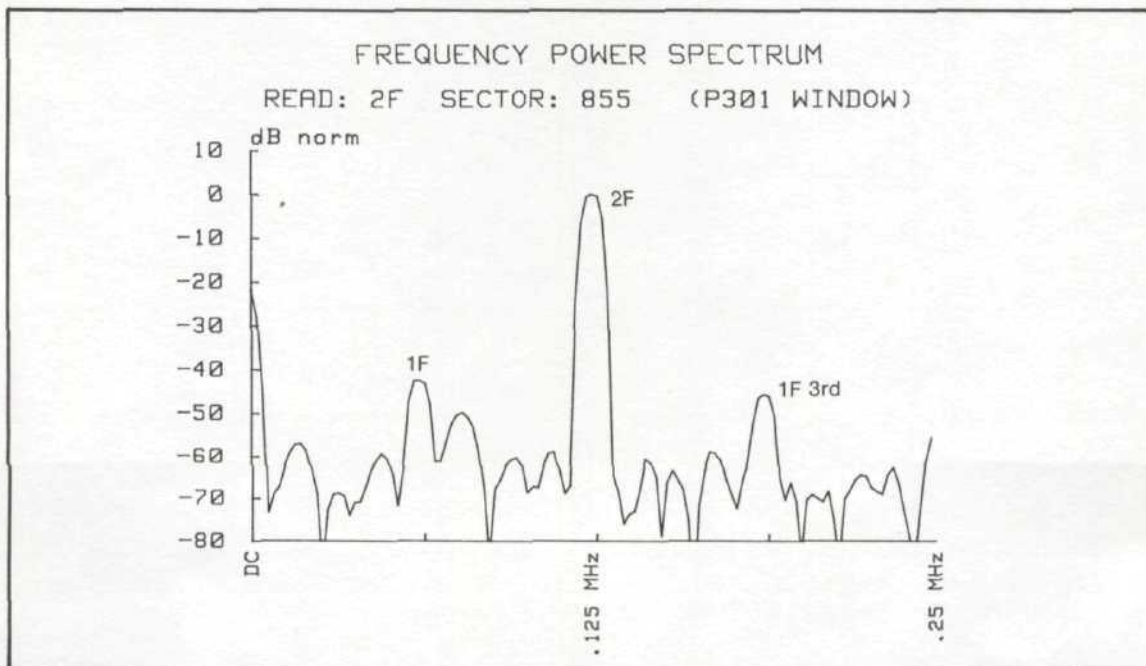

Figure 31. Power Spectrum for 2F overwrite 1F. The 1F fundamental at 62.5KHz is reduced to -42dB; 3rd harmonic, reduced to -45dB.

## CROSTALK SPECTRUM TESTS

The FFT processing used for pattern overwrite may be applied to determine crosstalk. The most common source of crosstalk is an adjacent data track, since high density recording places tracks as close as possible. Less often, the crosstalk source is a data or servo pattern on the opposite surface. Another source of interference is the coupling of servo signals into the analog read channels.

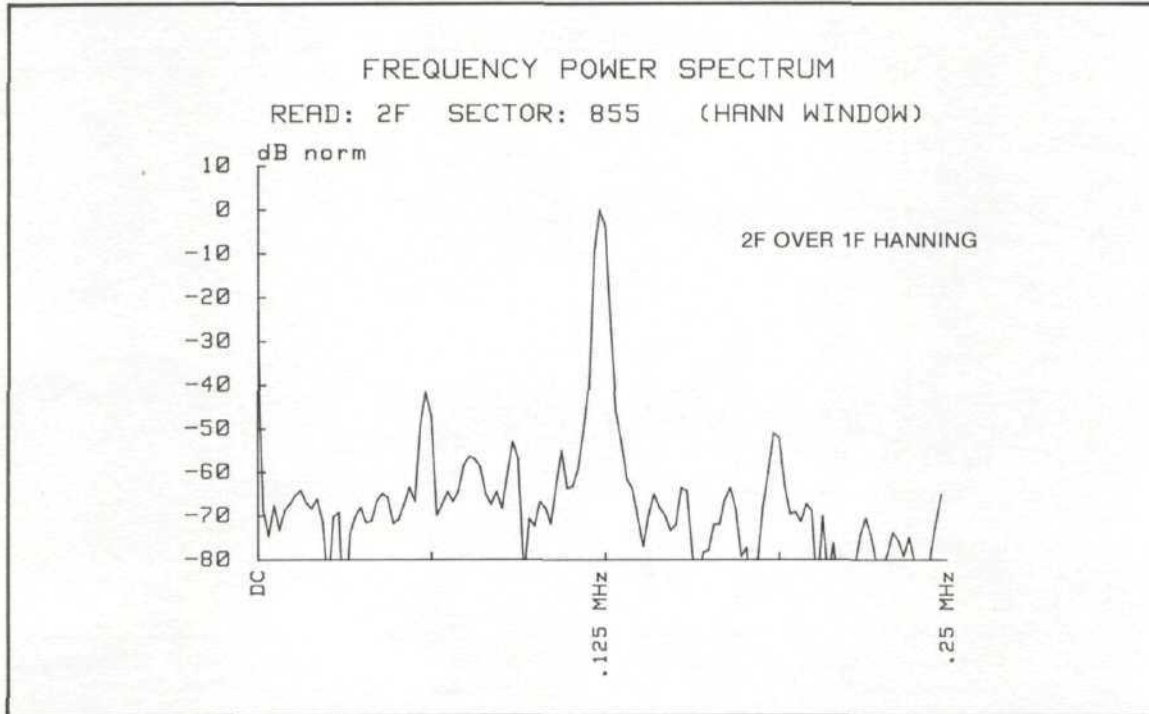

Figure 32. 2F overwrite 1F Power Spectrum using the Hanning window. Frequency lines are more sharply defined, although amplitude accuracy suffers.

A good reference plot for a crosstalk test is the spectrum of a particular sector with adjacent tracks DC-erased. Crosstalk may be determined by comparing sector spectrum plots before and after data is written to the other tracks. To determine servo signal interference, spectrum plots with and without servo positioning may be compared. The 5 $\frac{1}{4}$ " floppy drive does not use servo positioning and did not exhibit any measurable track crosstalk.

## Electronics and Media Noise

Excessive noise in the read signal can lead to single bit errors. Studies have shown that, depending on the detection scheme and code structure used, a signal-to-noise ratio of more than 30dB is generally required to support bit error rates of parts in 10E11.

The FFT Power Spectrum algorithm may be used to measure the signal-to-noise ratio (SNR) of the read waveform and locate interference components coming from internal or nearby electronic circuits. The sum of all noise found in a read signal has several sources which may be divided into two categories—electronics noise and media noise. Electronics noise comes from amplifiers, processor clocks, and radiated RFI from CRTs and motors. Media noise is an additive noise voltage that depends on the number of coating particles per unit volume. Another source of media noise is the substrate finish—peaks and valleys from surface tooling tend to modulate the read waveform. SNR is obtained from the FFT by calculating the RMS ratio of two signal sums all components related to the read signal and all noise components. As an example, the overwrite plot of Figure 32 is repeated in Figure 33. An electronics noise component at 109KHz, down 51dB from the 125KHz 2F fundamental, appears in most of the FFT plots and is interference from a nearby CRT.

Frequency domain testing using data conditioning and FFTs provides additional measurement capability not normally found in a disc test strategy. It has been shown that the FFT has numerous applications in design and offers the best measure of interference from overwritten patterns and system and media noise sources.

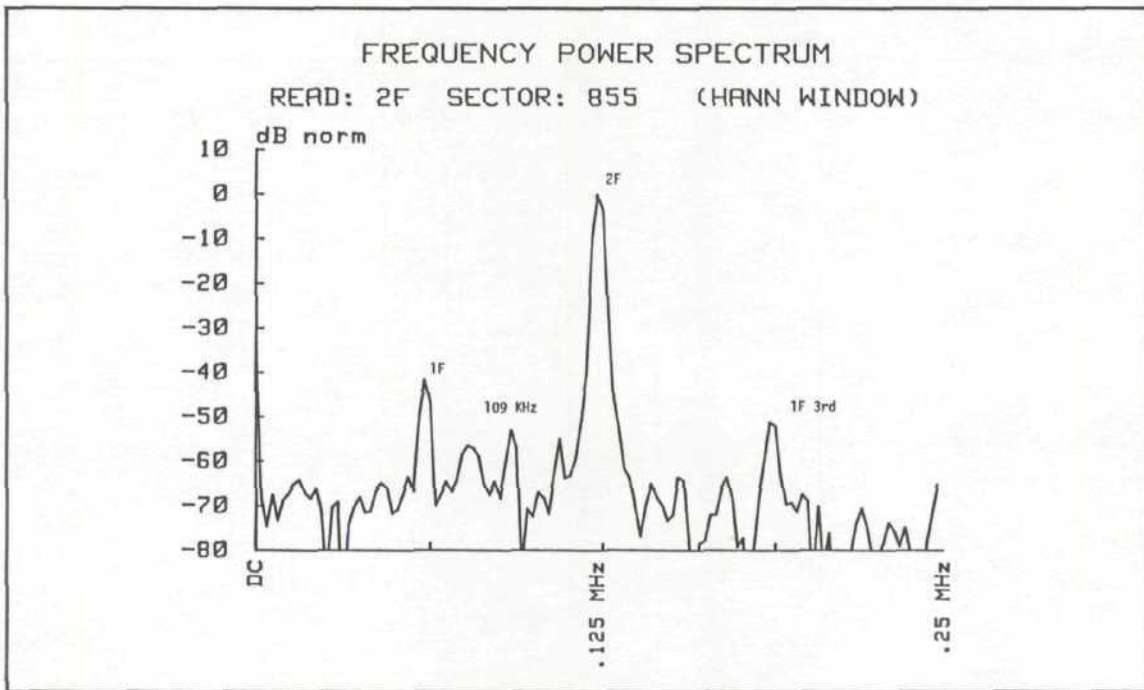

Figure 33. The Power Spectrum plot used to identify sources of electronics noise. This component at 109KHz, down 51dB from the 125KHz fundamental, is interference from a nearby CRT.

# APPENDIX I

## Important Waveform Recorder Specifications in Disc Testing

Primary factors that determine the applicability for the test concepts presented depend on capabilities of the waveform recorder. A list of 5180A Waveform Recorder features with important consequences in disc testing follow. Particular specifications and features mentioned are taken from the 5180A data sheet.

### Sample Rate:

Internal: 20Hz to 20MHz (50 msec/point to 50 nsec/point)

Higher sample rates allow single shot capture of disc waveforms. The major factor limiting application is the minimum acceptable number of points per cycle on the digitized waveform.

Example—A 4MHz sine wave captured using a sample period of 50 nsec/point contains five points per cycle.

External: External sample clocks may be applied through a rear panel input. Any clock frequency between 1MHz and 20MHz may be used to synchronize the sample clock to analog data being captured. An important concept, counted burst sampling, allows specifying a fixed number of samples on a per bitcell basis. The burst timebase conserves waveform recorder memory and simplifies processing.

### Input Channel Bandwidth:

40MHz Channel A,B and 70MHz AUX

This directly influences the investigation of rise time, bit shift, and Fourier phase relationships.

### High Speed Memory:

16384 Words.

Memory size directly determines the measurement sweep time. The number of points per cycle is initially determined by the sample rate. The total number of cycles that may be captured depends on the memory length chosen. In disc testing it is best to determine the maximum number of points per bitcell:

$$\text{Max \# points per bitcell} = 16384/\#\text{bitcells}$$

A sector length of 256 bytes may have up to 16 points per bitcell. The external burst timebase helps conserve memory by sampling over specified portions of each waveform cycle.

### Direct Memory Access (DMA):

Up to one million measurement words per second, depending on the computer used. Benchmark 9826/36: >500K Words per second.

The 16 bit parallel DMA port reduces test time by transferring 5180A captured data to the computer in parallel byte form and at a rapid rate.

**Trigger Positioning:**

Range: -100% of memory to +9999% of memory. May also be set in absolute time or number of sample points.

Pre- and post-trigger recording allows capturing data before, during, or after the trigger event. Precise trigger positioning is absolutely essential in capturing disc test signals. Common applications for variable trigger position include the recording of dropouts and subsector information fields (headers, sector gaps, sync bytes, and complete or partial data fields).

**Dynamic Performance:**

Complete dynamic performance specifications, appear in the 5180A data sheet. A major performance issue for waveform recorders applied in disc testing is that of nonlinearities in the analog-to-digital converter transfer function. Nonlinearity errors are responsible for the generation of input signal harmonics and tend to limit performance when performing frequency domain analysis.

Some of the tests outlined in this note depend on investigating the frequency spectrum using Discrete Fourier Transforms (FFT Overwrite, Noise Inspections). A low noise floor is essential in these investigations; typically the inspected frequency components are 40dB below fundamentals. Poor dynamic performance could bury the desired information in the noise floor.

The data sheet specification for DFT spurious Channel A or B is  $>46\text{dBc}$  for a full scale 9.85 MHz sinewave test frequency.

## APPENDIX II

# Demonstration Software

This appendix section provides additional information that is useful in implementing tests presented in this application note. The documentation given here does not explain each program statement, but is condensed to include essential concepts and subroutines. The Amplitude Histogram Test, however, has a complete program listing and serves as a typical example of the structure used in other tests.

### 5¼" Floppy Demonstration

The example software used in testing the 5¼" Floppy media and drive electronics is available through Hewlett-Packard's Series 200 Technical Computers Exchange Software Library. Information found in this Appendix is directly applicable to the routines available through Software Part 15.1106. Programs included on the supplied disc are those used to generate the example results given and must be modified to operate on disc drives having specifications and signal relationships different than those given for the 5¼" floppy. All programs are stored with comments that identify variables, described subroutines, and identify intermediate processing steps.

#### The following routines are included on the demonstration disc:

- "DMA\_\_READ" A utility that enables rapid transfer of 5180A measurement data to the 9826 Computer via the DMA 16-bit parallel I/O.
- "AMP\_\_HIST" Produces the Single Sector Amplitude test using a burst timebase capture method.
- "SECT\_\_AMP" Produces the Sector/Amplitude plot for two adjacent tracks. Uses the burst timebase explained in the Single Sector Amplitude routine.
- "READ\_\_ANAL" Routines that analyze the read waveform. Includes PW50, peak shift by comparing risetimes, and pulse symmetry by rise-time/fall-time comparison and integration.
- "PW\_\_HIST" Performs timing analysis of conditioned data streams (comparator output) and produces a time histogram of consecutive half pulse widths.
- "TIME\_\_MARG" Captures the DATA waveform referenced to the CLOCK and produces a time histogram of CLOCK edge to DATA edge intervals. Uses a burst timebase as explained in the section "DATA-CLOCK Time Margin Analysis".
- "FFT\_\_OVER" An FFT Power Spectrum Algorithm that allows comparing 1F-2F signal power when overwriting stored data. The routine includes a PASCAL CSUB FFT and LOG sub-program that executes at speeds 30 times that of BASIC. The benchmark execution time for 1024 captured data points is approximately 1 second.

## Equipment Required

The following list describes the equipment and configurations required to perform the disc media and electronics tests. The demonstration software is written to operate with these instruments.

5180A Waveform Recorder—no options required. Accessories required with the 5180A are as follows:

CRT Display May use any oscilloscope having 50 ohm XYZ inputs or one of the following large or small screen displays. For more information, refer to the 5180A Data Sheet or Hewlett-Packard Instrumentation Catalog.

Large screen: 1311B or 1310B

Small screen: 1332A (opt. 110.210.315)

1340A (opt 315)

10875A DMA Cable—used for 16-bit parallel data transfers.

10833A, B, C, or D HP-IB Cable—Two required. 9826 to 5180A and 5180A to 8112A Pulse Generator.

9826 or 9836 Desktop Computer—with following software/accessories

98622 Interface

98620A DMA Board (optional for fastest DMA)

1 M byte memory (minimum)

BASIC 2.0 with BASIC EXTENSIONS 2.0

8112A Pulse Generator—no options required. The 8112A is required for routines that are based on the external burst timebase—Amplitude Histogram, Sector/Amplitude, and Data/Clock Time Margin Analysis.



## EXAMPLE PROGRAM—Single Sector Amplitude Histogram Test

The Single Sector Amplitude Test is offered as an example of the program structure found in the demonstration routines. A complete listing follows the descriptions.

**Routine:** SINGLE SECTOR AMPLITUDE HISTOGRAM TEST

**File Name:** "AMP\_HIST" ("\_" is the underscore character)

**Description:** Media test that uses a burst counted timebase to capture peaks of the disc read signal and catalog those peaks in a histogram (occurrence vs. voltage). The captured waveform is that obtained from a 2F pattern (MFM ...000...).

**Equipment Configuration:** Refer to Figure 7.

## SUBROUTINE EXECUTION—Single Sector Amplitude Histogram Test

- Init:** Allocates arrays, sets I/O path names, and presets variables.
- Set5180:** Programs 5180A for burst timebase capture of the disc read signal.
- Set8112:** Programs the 8112A Pulse Generator for burst timebase operation. Voltage output is set at 2V p-p with 0V offset (generator output is applied to the 5180A TIME BASE rear panel input). The burst is set for 16 samples spaced at 250 nsec.
- Setdisc:** Arms the 5180A for capture of a single sector read head signal. Repeats the arm and disc read operation so that the 8112A trigger level may be adjusted.
- Xferdata:** DMA transfer routine. 16384 measurement words from the 5180A transferred to the array "Data" (don't confuse with the DATA keyword).
- Getgroups:** Control subroutine that indexes each group of 16 samples representing each waveform peak.
- Sortmax:** Finds the peak voltage in each group of 16 samples and stores that voltage in the appropriate location of the histogram (Hist) array. The first sample in each group is not counted because the spacing between that sample and the last sample of the previous group is greater than 1 $\mu$ sec. The array "Error" stores the bitcell location of any peak lower than the voltage given by the variable "Limit".
- Stats:** Computes statistics for the "Histogram" array.
- Graph:** Subroutine to graph the "Histogram" array data. Provides for output to the internal 9826 display or an external HP-GL plotter.

```
10      !AMPLITUDE HISTOGRAM
20      !SINGLE SECTOR
30      !APR 14, '83
40      !
50      !Plots amp histogram for peaks from
60      !single sector read operation.
70      !
80      !Stored on disc as "AMP_HIST"
90      !
100     !Disc signal is input to 8112A trigger
110     !and 5180A Chan A (using TEC CONNECTOR).
120     !
130     !8112A output to 5180A EXT TIMEBASE
140     !
150     !5180A EXT TRIG from disc DRQ
160     !Falls first byte into DATA field.
170     !
180     !Disc pattern is MFM 2F (all 0's)
190     !
200     !*****
```

```

210 !MAIN EXECUTION GOSUBS
220 GOSUB Init
230 GOSUB Set5180
240 GOSUB Set8112
250 GOSUB Setdisc
260 GOSUB Xferdata
270 GOSUB Getgroups
280 GOSUB Stats
290 GOSUB Graph
300 GOTO End
310 !*****
320 Init: !Sets arrays, variables, I/O paths.
330 GCLEAR !clear previous graphics
340 DISP "" !clear display
350 PRINT USING "@" !clear printed text
360 !
370 OPTION BASE 1
380 INTEGER Data(16384) BUFFER !DMA buffer
390 INTEGER Hist(1024),Error(1024)
400 INTEGER I !speeds FOR/NEXT counting
410 !
420 N=16 !number of samples in each burst
430 Last=1018 !last group in the captured sector
440 Limit=723 !voltage code limit for detecting errors
450 !Voltage = (Range)*(.002)*(Limit-512)
460 !Limit voltage = 0.422V for the disc drive tested
470 !
480 Range=1 !range of 5180
490 Min=1023 !used for min/max calculation
500 Max=0 !used for min/max calculation
510 !
520 ASSIGN @Hp5180 TO 704
530 ASSIGN @Hp8112 TO 702
540 Gpio=12 !GP-ID ADDRESS for DMA
550 ASSIGN @Dma TO Gpio;WORD
560 ASSIGN @Buf TO BUFFER Data(*);WORD
570 BEEP
580 !
590 INPUT "INSERT THE TEST DISC AND SECTOR#".Sector
600 !
610 RETURN
620 !*****
630 Set5180: !Sets up 5180A.
640 DISP "SETTING UP 5180A"
650 OUTPUT @Hp5180:"PRSA1" !preset and set single sweep
660 OUTPUT @Hp5180:"LE16384,PA0.TE1.Z0256.P00"
670 !previous line sets:
680 !Length=16384
690 !Trigger position 0 samples.
700 !External timebase
710 !Display zoom = 256 pts.
720 !Display position = 0 pts.
730 !
740 OUTPUT @Hp5180:"SE1.SL0,LV2.5.AC1,D0"
750 !previous line sets:
760 !External trigger, positive slope, 2.5V
770 !AC couple CHAN A
780 !Display dot mode
790 !
800 OUTPUT @Hp5180:"AR".Range
810 RETURN
820 !*****

```

```

830 Set8112:      !Sets up 8112A pulse generator.
840              !Burst mode 16 samples spaced 250nsec
850              !
860      DISP "SETTING UP 8112A"
870      OUTPUT @Hp8112:"HIL1V,LOL-1V,CT0,T1,W1,M5"
880      OUTPUT @Hp8112:"PER250NS,DEL65NS,DTY50%"
890      OUTPUT @Hp8112:"LEE4.5NS,TRE4.5NS,BUR16#"
900      OUTPUT @Hp8112:" D0"
910      RETURN
920      !*****
930 Setdisc:     ! Sub to operate disc & capture data.
940              ! Repeats sector read so that 8112A
950              ! trigger may be adjusted.
960              !
970              !
980      !begin trigger adjustment loop
990      DISP "ADJUST TRIG LEVEL - ANY KEY TO CONTINUE"
1000     ON KBD GOTO 1070
1010     OUTPUT @Hp5180:"SA4" !arms 5180A
1020     !
1030     !DISC READ STATEMENT GOES HERE *****
1040     !SECTOR TO BE READ IS Sector *****
1050     !
1060     GOTO 1010
1070     OFF KBD
1080     !end of trigger adjustment loop
1090     !
1100     OUTPUT @Hp5180:"SA4" !arms 5180A
1110     !
1120     !DISC READ STATEMENT GOES HERE *****
1130     !SECTOR TO BE READ IS Sector *****
1140     !
1150     IF BIT(SPOLL(@Hp5180),3)=1 THEN
1160         DISP "WAITING FOR 5180A"
1170         GOTO 1150
1180     END IF
1190     DISP "MEASUREMENT FINISHED"
1200     RETURN
1210     !*****
1220 Xferdata:   !DMA data transfer/ GP-IO ADDR 12
1230     !TRANSFER statement COUNT = 2X 5180A length
1240     !5180A length = 16384
1250     !
1260     DISP "TRANSFER DATA"
1270     CONTROL @Buf,4;0
1280     CONTROL Gpio,0;2
1290     CONTROL Gpio,3;0
1300     STATUS Gpio,3;Stat !sets I/O to READ
1310     CONTROL Gpio,2;1
1320     TRANSFER @Dma TO @Buf:COUNT 32768,WAIT
1330     CONTROL Gpio,2;0
1340     CONTROL Gpio,1;!
1350     RETURN
1360     !*****
1370 Getgroups:  !Subroutine to control group sorting.
1380             !
1390     DISP "LOCATING PEAKS"
1400     FOR Group=1 TO Last
1410         GOSUB Sortmax
1420     NEXT Group
1430     RETURN
1440     !*****
1450 Sortmax:    !Finds max code in each group
1460             !and catalogs it in the Hist array.
1470             !
1480     Locmax=0 !Locmax is peak code in each group
1490     !
1500     !Loop to sort each group of N and find peak.
1510     !First sample is not counted.

```

```

1520 !
1530 FOR I=(Group-1)*N+2 TO (Group-1)*N+N
1540   Samp=Data(I)
1550   IF Samp>=Locmax THEN
1560     Locmax=Samp
1570   END IF
1580 NEXT I
1590 !end sort loop
1600 !
1610 IF Locmax<Limit THEN
1620   Errorcount=Errorcount+1 !counts # of peaks
1630   !that have voltage less than Limit
1640   !
1650   Error(Errorcount)=Group !array keeps
1660   !bitcell location of errors
1670   !
1680 END IF
1690 IF Locmax<Min THEN Min=Locmax
1700 IF Locmax>Max THEN Max=Locmax
1710 !
1720 Hist(Locmax)=Hist(Locmax)+1 !increments the histogram
1730 !
1740 RETURN
1750 !*****
1760 Stats: !Histogram statistics.
1770 DISP "STATISTICS"
1780 FOR I=Min TO Max
1790   IF Hist(I)>Histmax THEN
1800     Histmax=Hist(I)
1810     Topbin=I !Voltage bin having highest occurrence.
1820     !
1830   END IF
1840 NEXT I
1850 Topvolts=(Topbin-512)*.002*Range !hist peak volts
1860 Histwidth=(Max-Min)*.002*Range !histogram
1870 !basewidth in volts
1880 !
1890 RETURN
1900 !*****
1910 Graph: !histogram graph subroutine
1920 CONTROL 1,12;! !turns off soft keys
1930 DISP "" !clears display
1940 PRINT USING "@" !clear printed statements
1950 GINIT
1960 INPUT "EXTERNAL PLOTTER Y or N?";Q$
1970 IF Q$="Y" OR Q$="y" THEN
1980   PLOTTER IS 705."HPGL"
1990   OUTPUT 705;"VS4" !plotter speed
2000 END IF
2010 GCLEAR
2020 GRAPHICS ON
2030 !
2040 !Label
2050 FRAME
2060 VIEWPORT 15,120,20,75
2070 Top=INT(Histmax*1.25)
2080 WINDOW 512,1024,0,Top
2090 CLIP 512,1024,0,Histmax
2100 AXES 32,Top,512,0
2110 CLIP OFF
2120 DEG
2130 CSIZE 4
2140 LDIR 90
2150 LORG 8
2160 FOR I=512 TO 1024 STEP 128
2170   MOVE I,-2
2180   LABEL USING "D.000";Range*(I-512)*.002
2190 NEXT I
2200 LORG 2

```

```

2210 LDIR 0
2220 MOVE Topbin+20,Histmax
2230 LABEL USING "D.DDD":Topvolts
2240 MOVE Topbin+100,Histmax
2250 LABEL "(PEAK)"
2260 LORG 4
2270 LDIR 90
2280 MOVE 510,Histmax/2
2290 LABEL "OCCURRENCE"
2300 LDIR 0
2310 LORG 8
2320 MOVE 510,Histmax
2330 LABEL Histmax
2340 MOVE Limit,Top
2350 LDIR 90
2360 LORG 8
2370 CSIZE 3
2380 LABEL "LIMIT"
2390 LINE TYPE 4
2400 MOVE Limit,.8*Top
2410 DRAW Limit,0
2420 !
2430 !Data
2440 LINE TYPE 1
2450 FOR I=Min TO Max
2460     MOVE I,0
2470     DRAW I,Hist(I)
2480 NEXT I
2490 !
2500 !Title
2510 VIEWPORT 0,133.0,100
2520 WINDOW 0,133.0,100
2530 LORG 6
2540 LDIR 0
2550 CSIZE 5
2560 MOVE 66.5,98
2570 LINE TYPE 1
2580 LABEL "AMPLITUDE HISTOGRAM"
2590 LORG 6
2600 CSIZE 4
2610 MOVE 66.5,92
2620 LABEL "SECTOR: ";Sector;"PATTERN: 2F"
2630 CSIZE 3.5
2640 MOVE 66.5,86
2650 LABEL "LIMIT: ";(Limit-512)*.002*Range
2660 PENUP
2670 RETURN
2680 !*****
2690 End: !
2700 PAUSE
2710 CONTROL 1,12:0 !turns on soft keys
2720 END

```

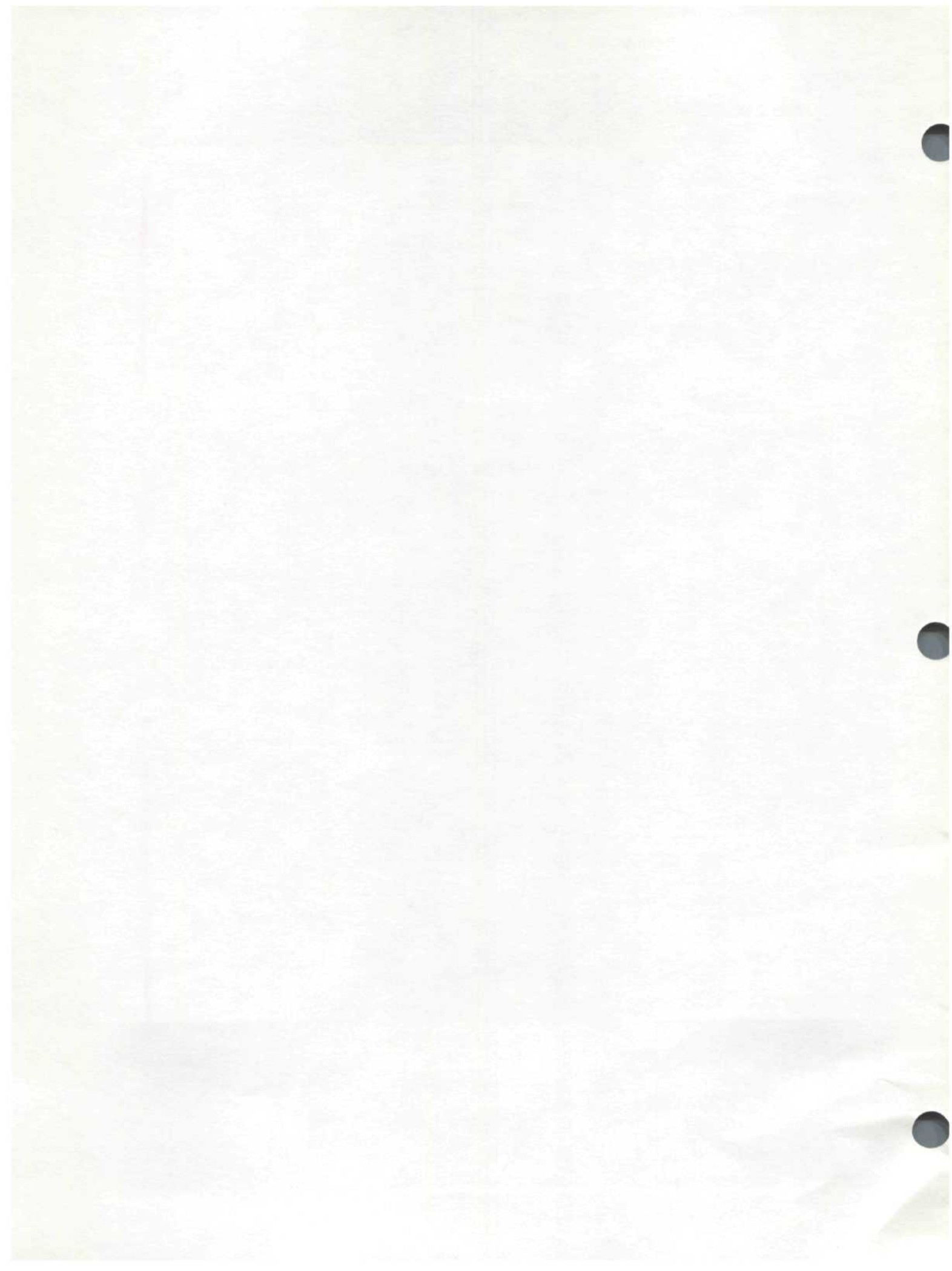

## HELPFUL INFORMATION

### **Additional documentation referenced by this note includes:**

Product Note 5180A-1-Understanding the 5180A Waveform Recorder.

Programming Note 5180/9826-1-Introductory Operating Guide for the HP 5180A Waveform Recorder with the HP 9826 Computer System.

Product Note 5180A-3-General Purpose Subroutines for the 5180A Waveform Recorder. Note: this document describes programming issues using the HP 9825 computer. Key concepts may be translated and applied to the 9826 Computer.

Application Note AN313-8-Using the Direct Memory Access Capability of the HP 5180A Waveform Recorder with the HP 9826 Desktop Computer.

Application Note AN243-Fundamentals of Signal Analysis.

IEEE Std 181-1977-IEEE Standard on Pulse Measurement and Analysis by Objective Techniques.

HP Publication 02-5952-0705-Compilation of Time Windows for Fourier Analysis.



HEWLETT  
PACKARD